



**MILITARY MARITIME  
KING KILLER WHALE**

Products and services insured by



TechnoKontrol is a member of the



**National Fire Protection Association**  
The authority on fire, electrical, and building safety

# INDEX

4	King Killer Whale
10	King Killer Whale - Heavy Helicopter Carrier
14	King Killer Whale - Mega Multi-Use Vessel
18	King Killer Whale - Long Range Radar
22	King Killer Whale - High Speed Patrol Vessel Carrier
28	King Killer Whale - Heavy Fuel Carrier
32	King Killer Whale - Plasma Fusion Gunship
36	King Killer Whale - Aerial-Maritime-Terrestrial Refueling Vessels



KING KILLER WHALE







# KING KILLER WHALE HEAVY MULTI-USE CARRIER

The King Killer Whale can carry up to 6 Eagle Eye airplanes and has 2 integrated cranes to load/unload airplanes into position.





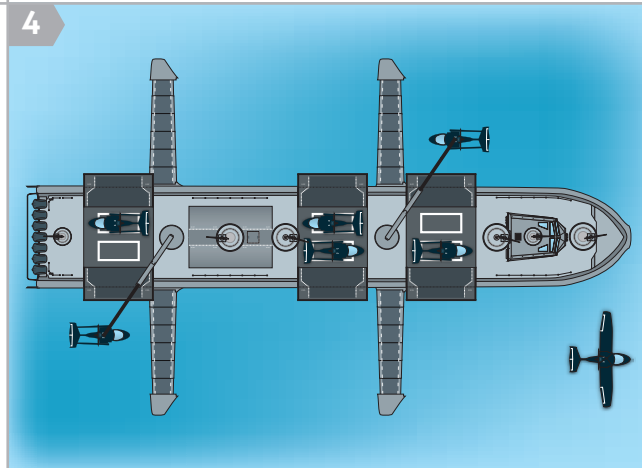
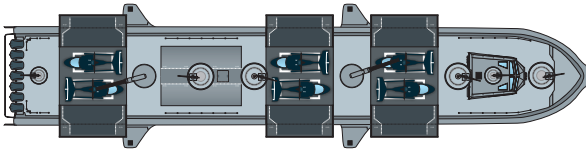
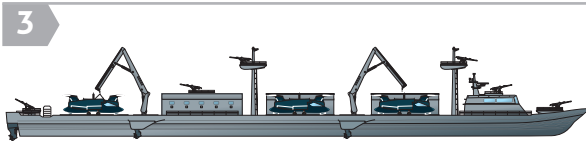
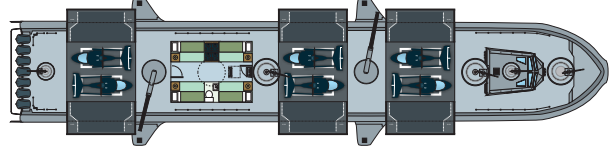
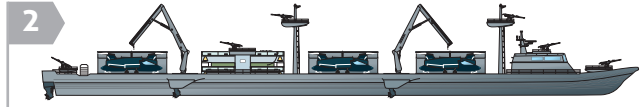
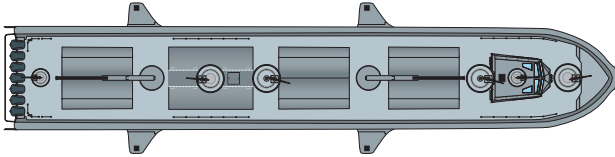
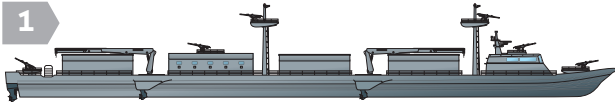

Technokontrol © Copyright. All Rights Reserved. All Designs & Applied Technologies Patented



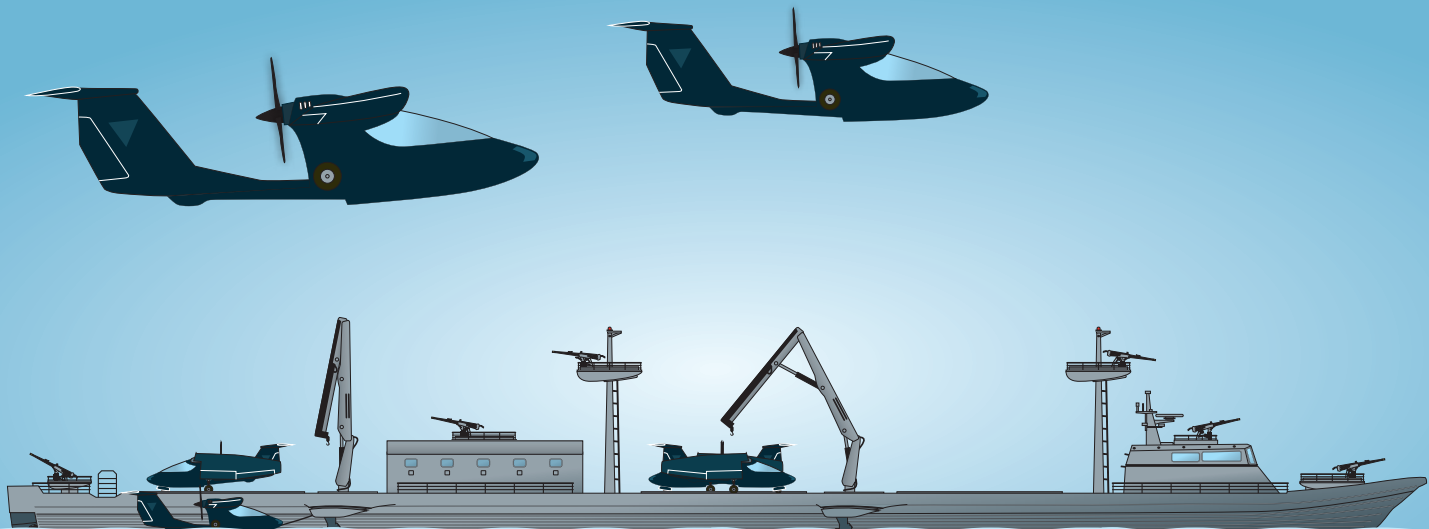

## KING KILLER WHALE

### CHARACTERISTICS & MORE INFORMATION

 [Click here to visit King Killer Whale web and watch a deployment animation](#)



# KING KILLER WHALE HEAVY HELICOPTER CARRIER



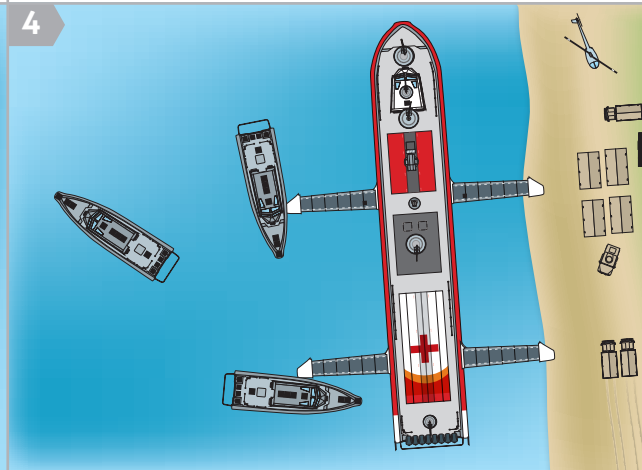
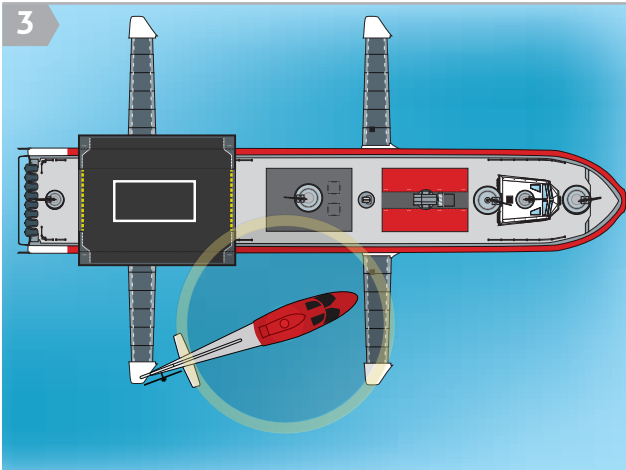
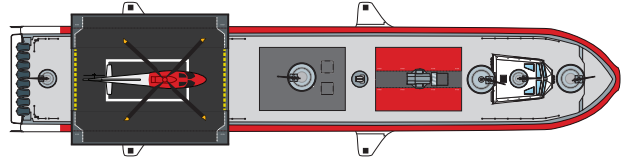
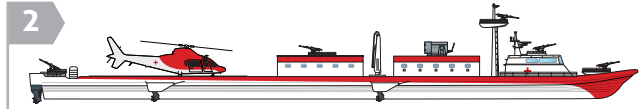
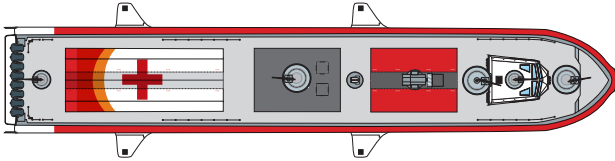
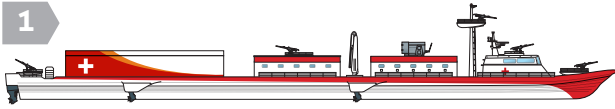

Technokontrol © Copyright. All Rights Reserved. All Designs & Applied Technologies Patented





BEWARE OF TAIL ROTOR



# KING KILLER WHALE MEGA MULTI-USE VESSEL





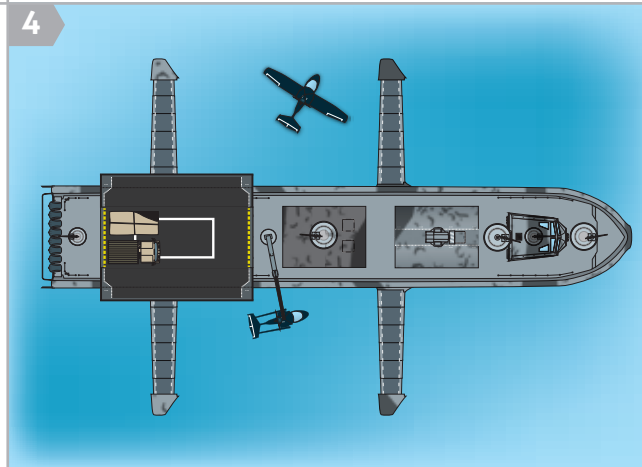
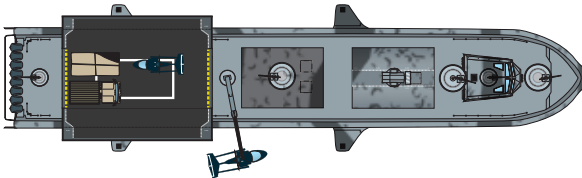
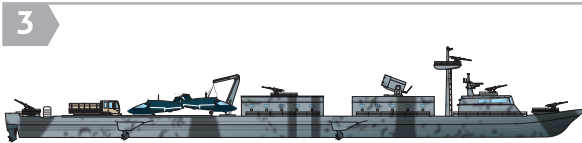
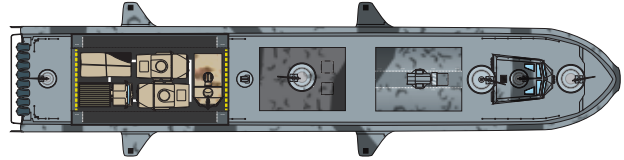
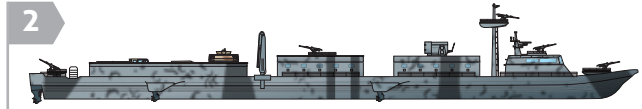
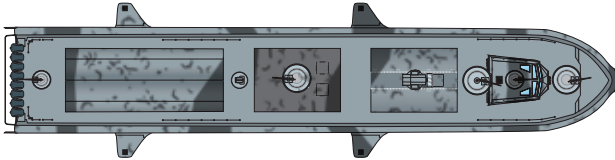
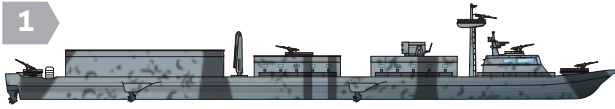

Technokontrol © Copyright. All Rights Reserved. All Designs & Applied Technologies Patented



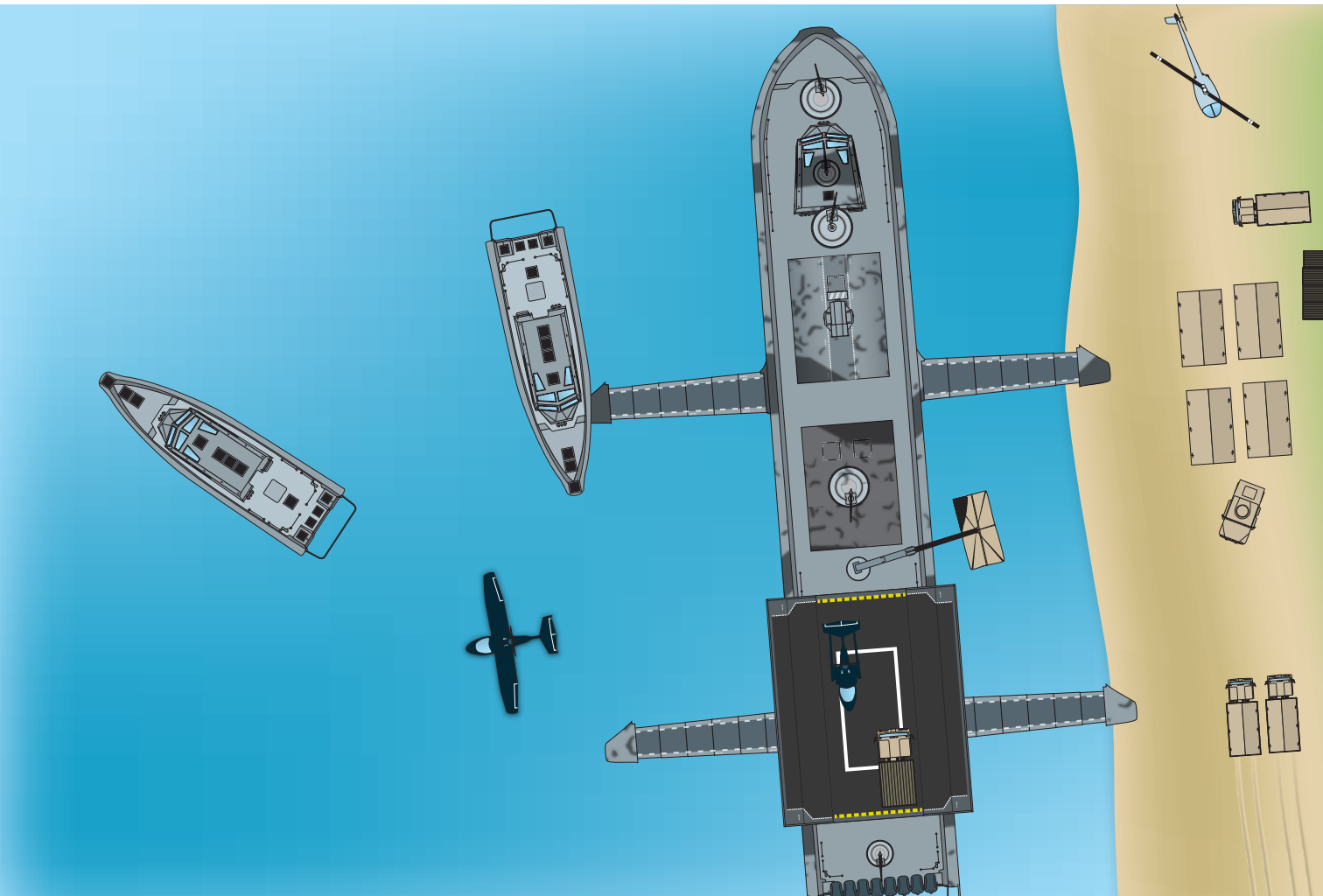

## KING KILLER WHALE - MEGA MULTI-USE VESSEL

CHARACTERISTICS & MORE INFORMATION

[Click here to visit King Killer Whale web and watch a deployment animation](#)

# KING KILLER WHALE LONG RANGE RADAR



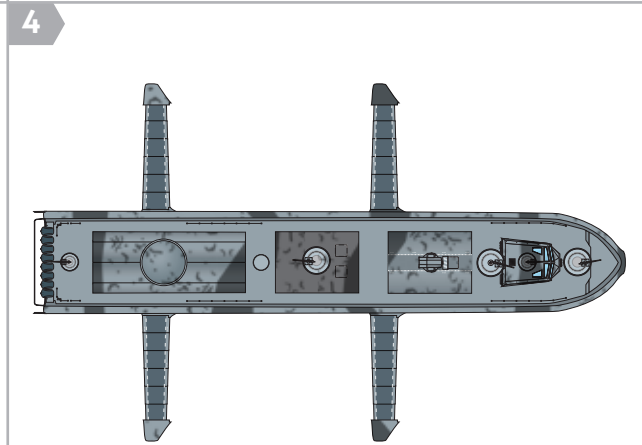
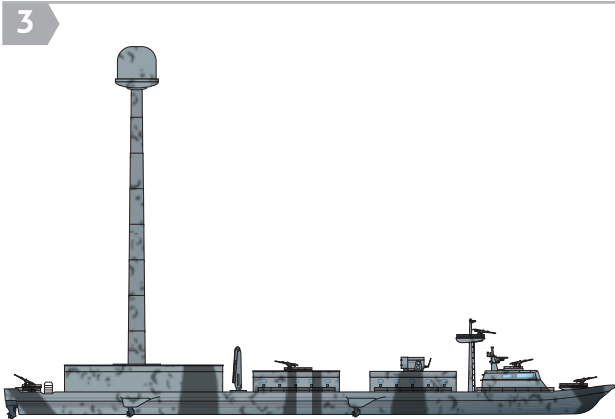
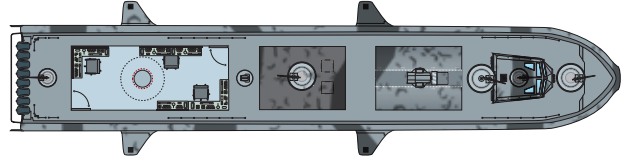
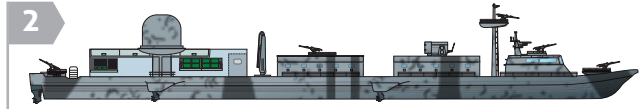
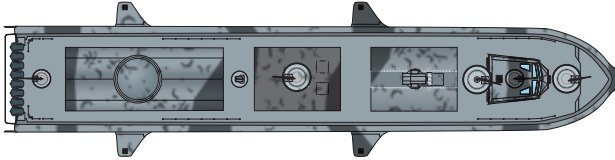
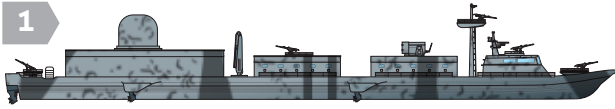

Technokontrol © Copyright. All Rights Reserved. All Designs & Applied Technologies Patented



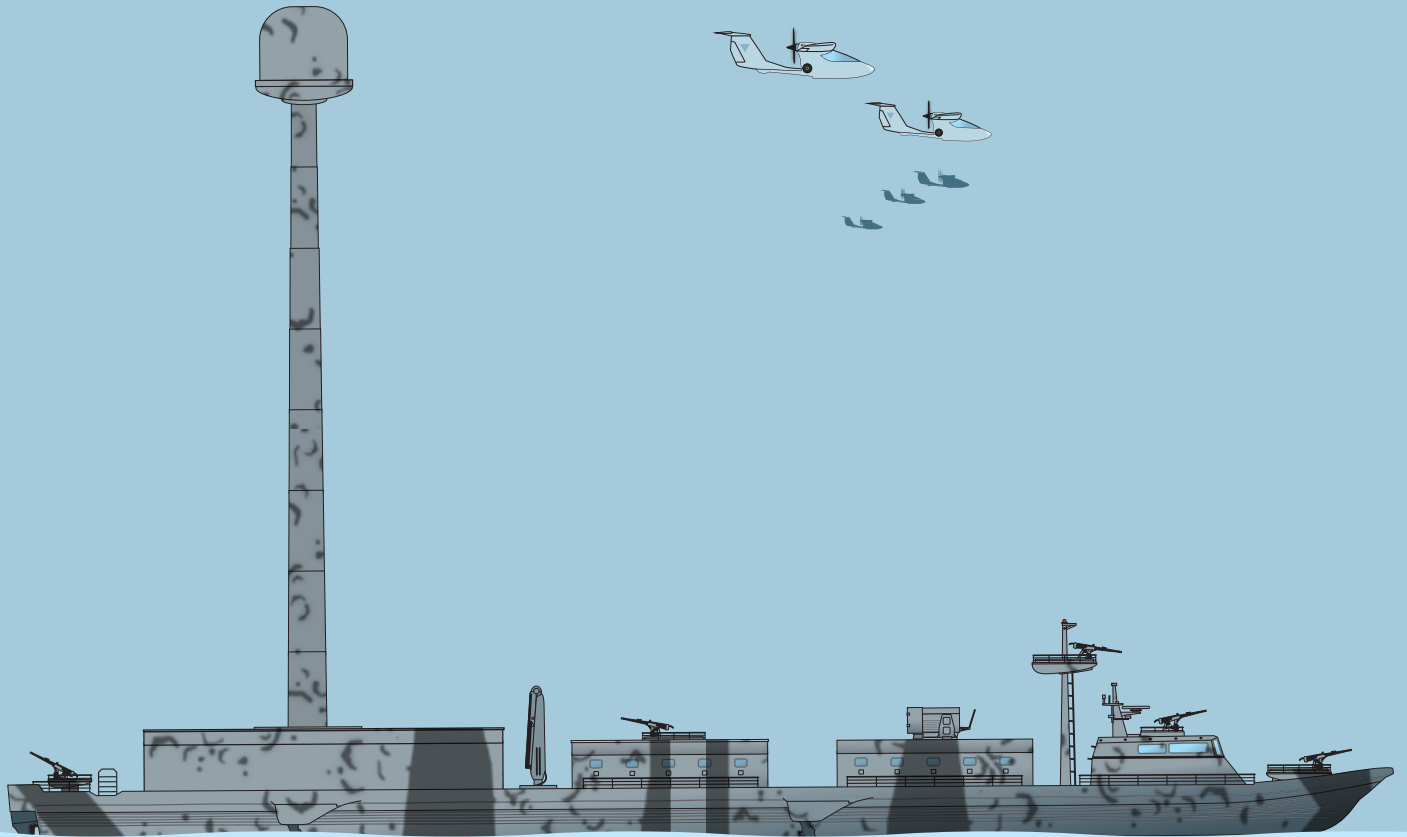

## KING KILLER WHALE - LONG RANGE RADAR

CHARACTERISTICS & MORE INFORMATION

[Click here to visit King Killer Whale web and watch a deployment animation](#)



# KING KILLER WHALE HIGH SPEED PATROL VESSEL CARRIER

ELITE GHOST DIVISION SPECIAL TASK FORCE VESSELS





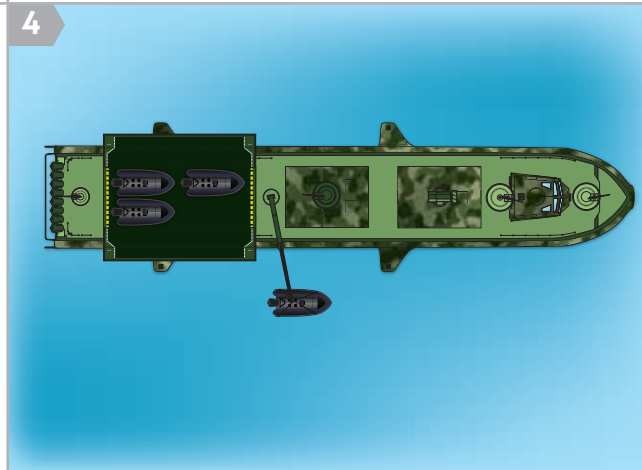
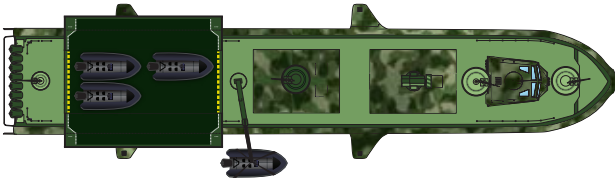
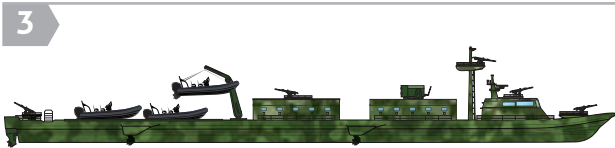
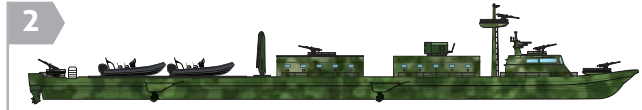

Technokontrol © Copyright. All Rights Reserved. All Designs & Applied Technologies Patented

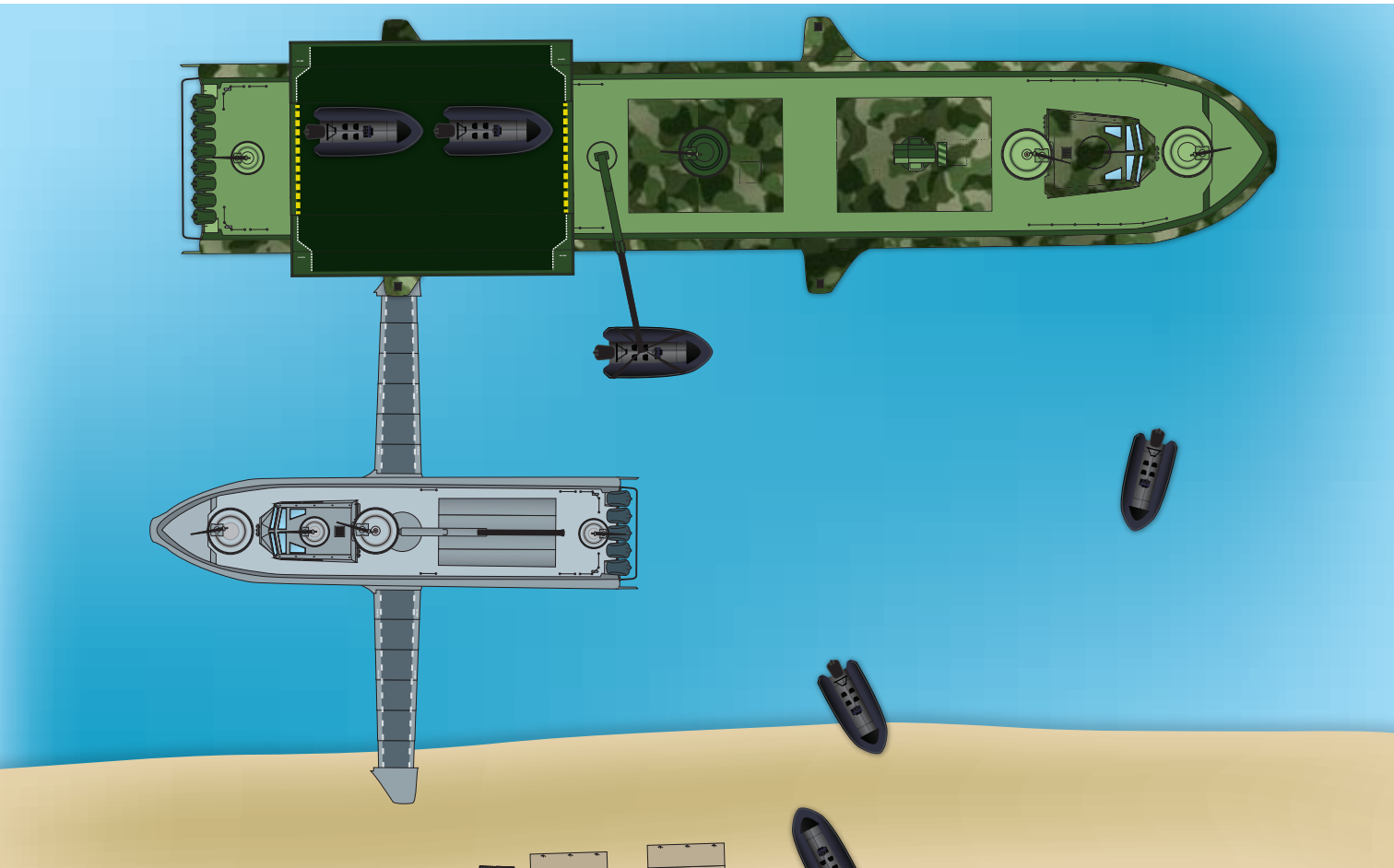

## KING KILLER WHALE - HIGH SPEED PATROL VESSEL CARRIER

### CHARACTERISTICS & MORE INFORMATION

[Click here to visit King Killer Whale web and watch a deployment animation](#)





Elite  
Ghost Division





# KING KILLER WHALE HEAVY FUEL CARRIER







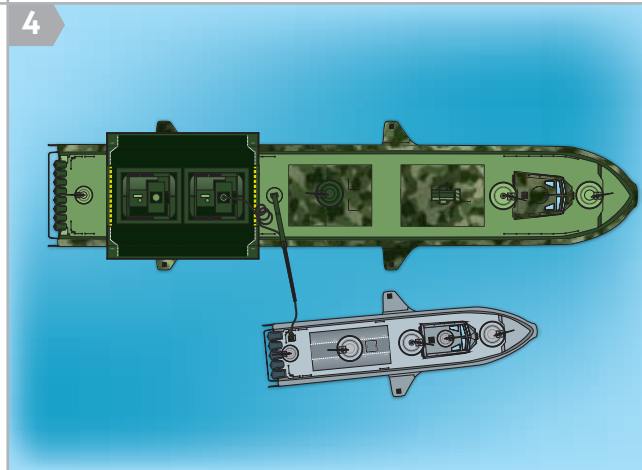
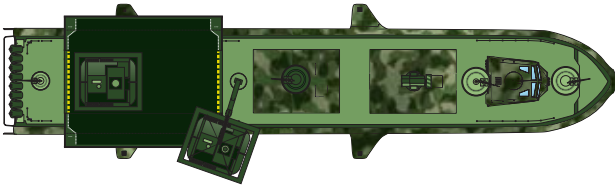
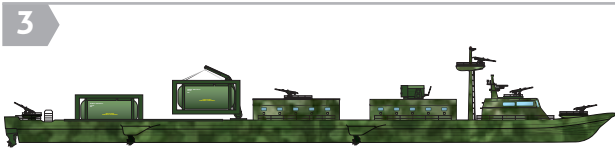
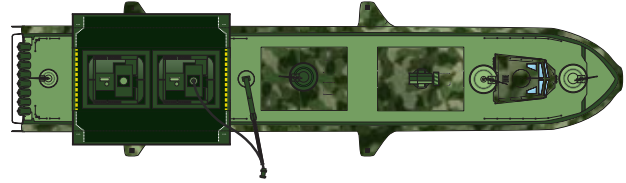

Technokontrol © Copyright. All Rights Reserved. All Designs & Applied Technologies Patented

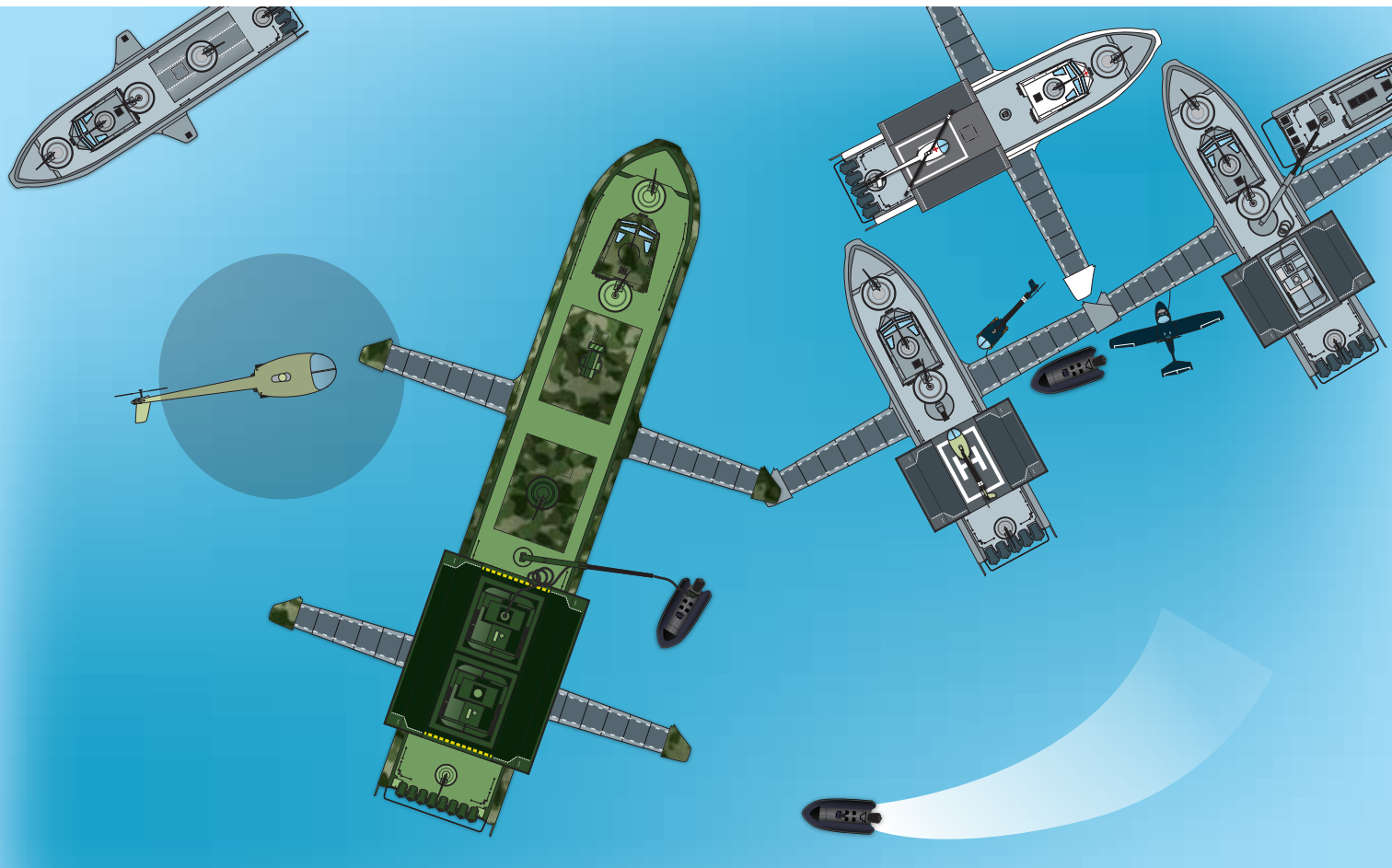

## KING KILLER WHALE -HEAVY FUEL CARRIER

### CHARACTERISTICS & MORE INFORMATION

[Click here to visit King Killer Whale web and watch a deployment animation](#)





# KING KILLER WHALE PLASMA FUSION GUNSHIP



1

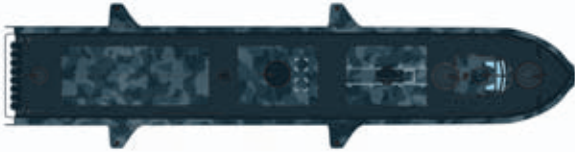

2



3



4

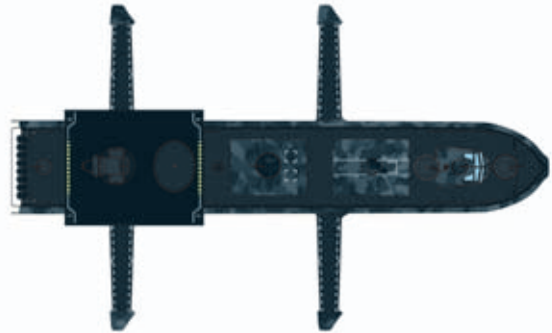

Technokontrol © Copyright. All Rights Reserved. All Designs & Applied Technologies Patented



## KING KILLER WHALE - PLASMA FUSION GUNSHIP

### CHARACTERISTICS & MORE INFORMATION

[Click here to visit King Killer Whale web and watch a deployment animation](#)





# KING KILLER WHALE AERIAL-MARITIME-TERRESTRIAL REFUELING VESSELS

BAD WEATHER, NIGHT, EMERGENCY, COMBAT "T-PLATTFORM" VESSEL  
REFUELING/MUNITIONS LANDING "TOUCH & GO" SAFETY PLATAFORMS



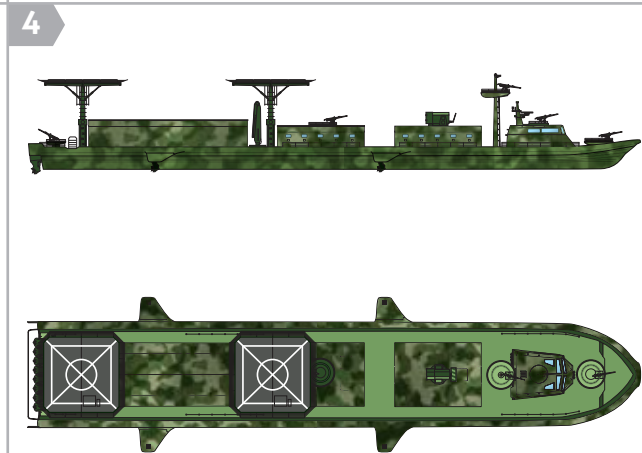
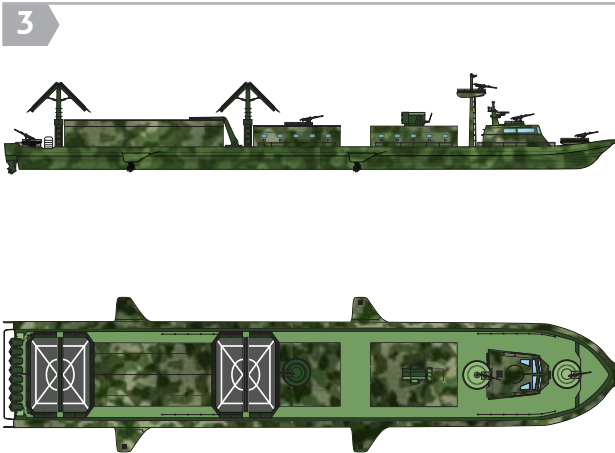
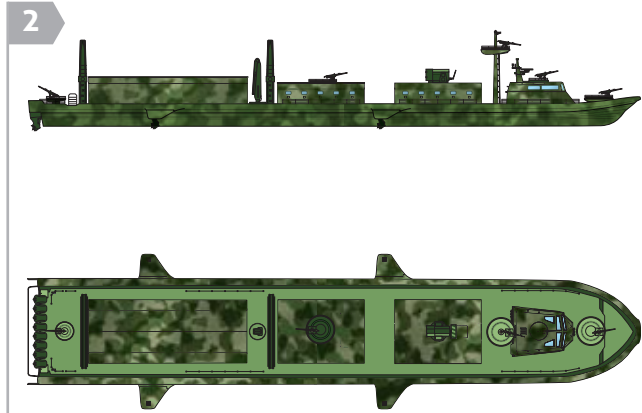
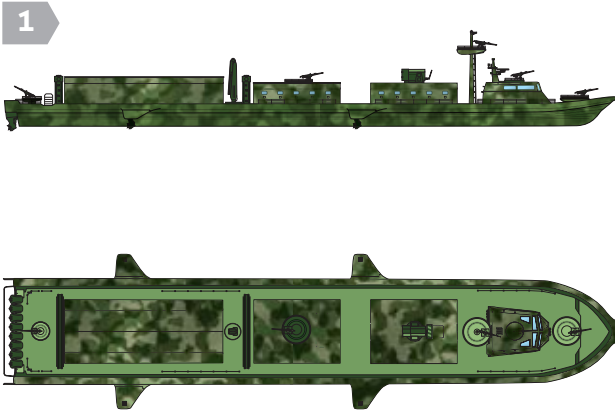

Technokontrol © Copyright. All Rights Reserved. All Designs & Applied Technologies Patented



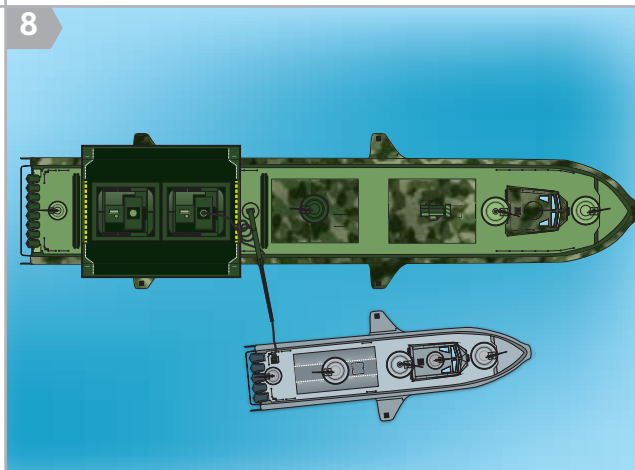
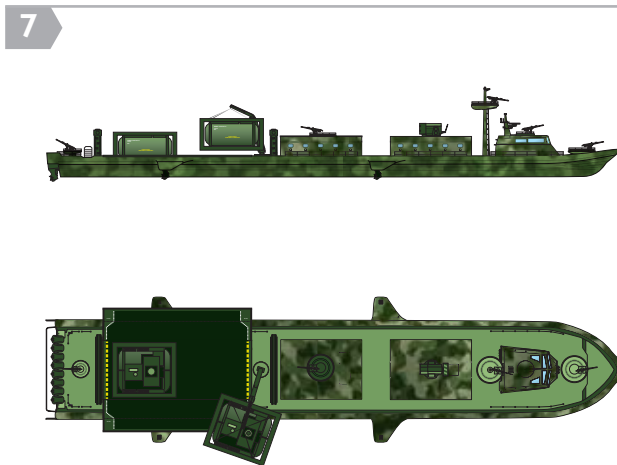
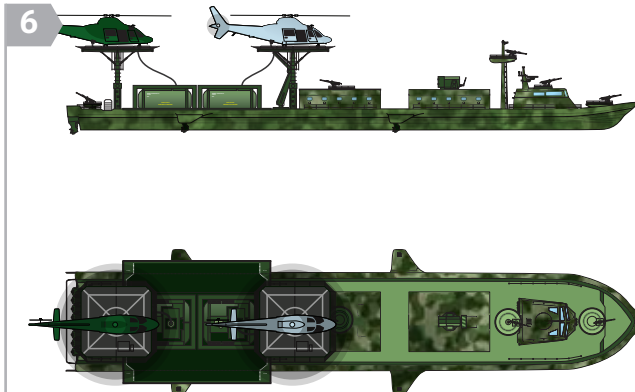
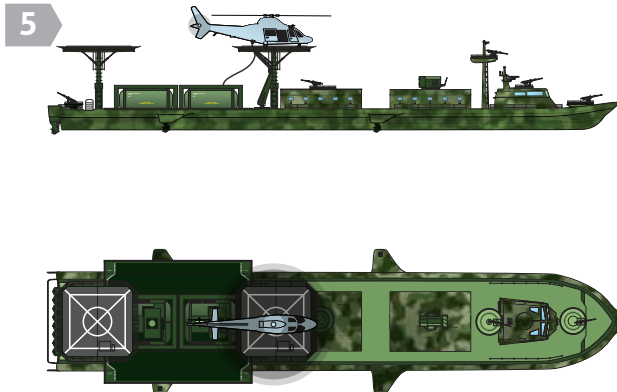

## KKW - AERIAL-MARITIME-TERRESTRIAL REFUELING VESSELS

### CHARACTERISTICS & MORE INFORMATION

 [Click here to visit King Killer Whale web and watch a deployment animation](#)

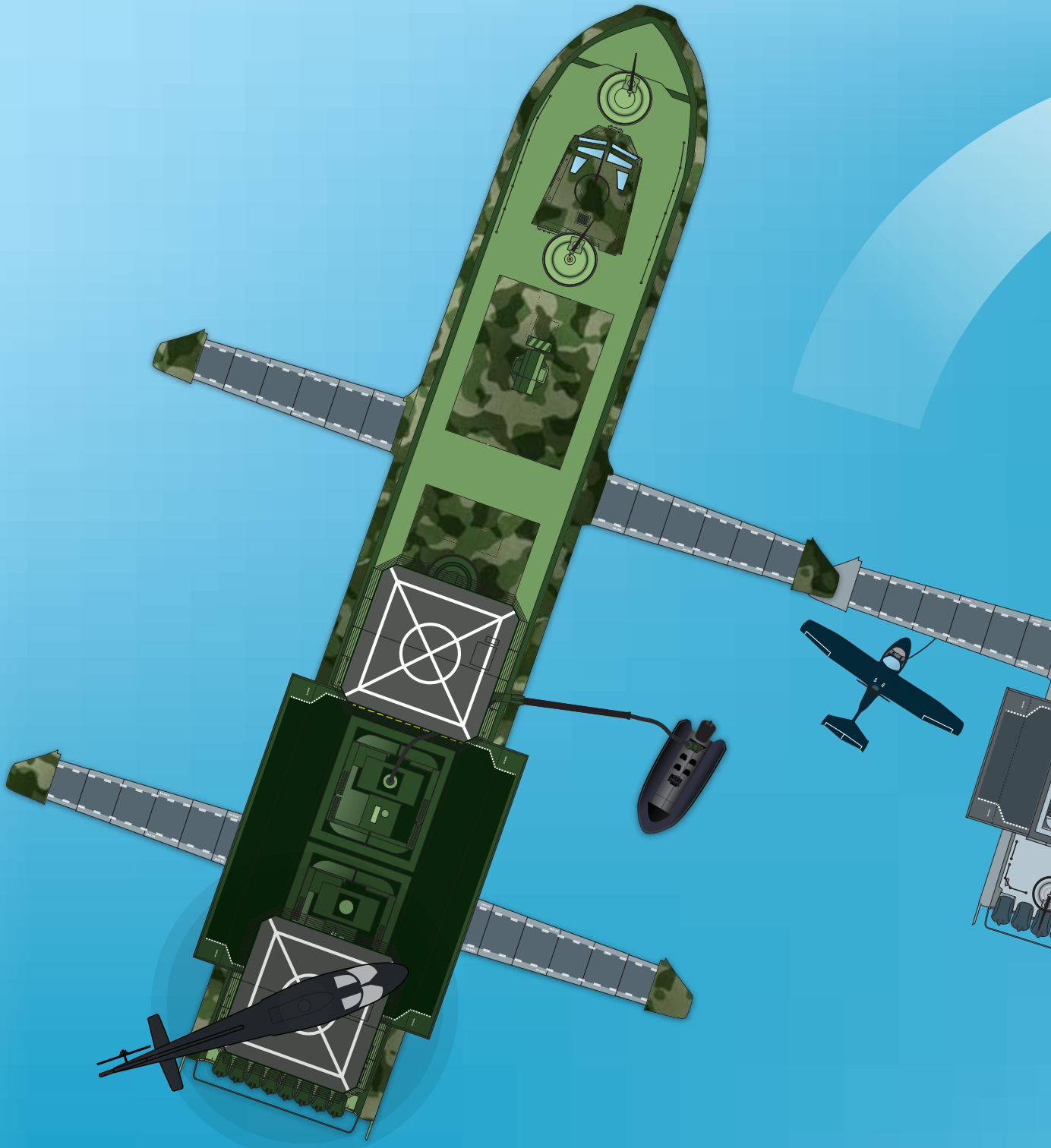

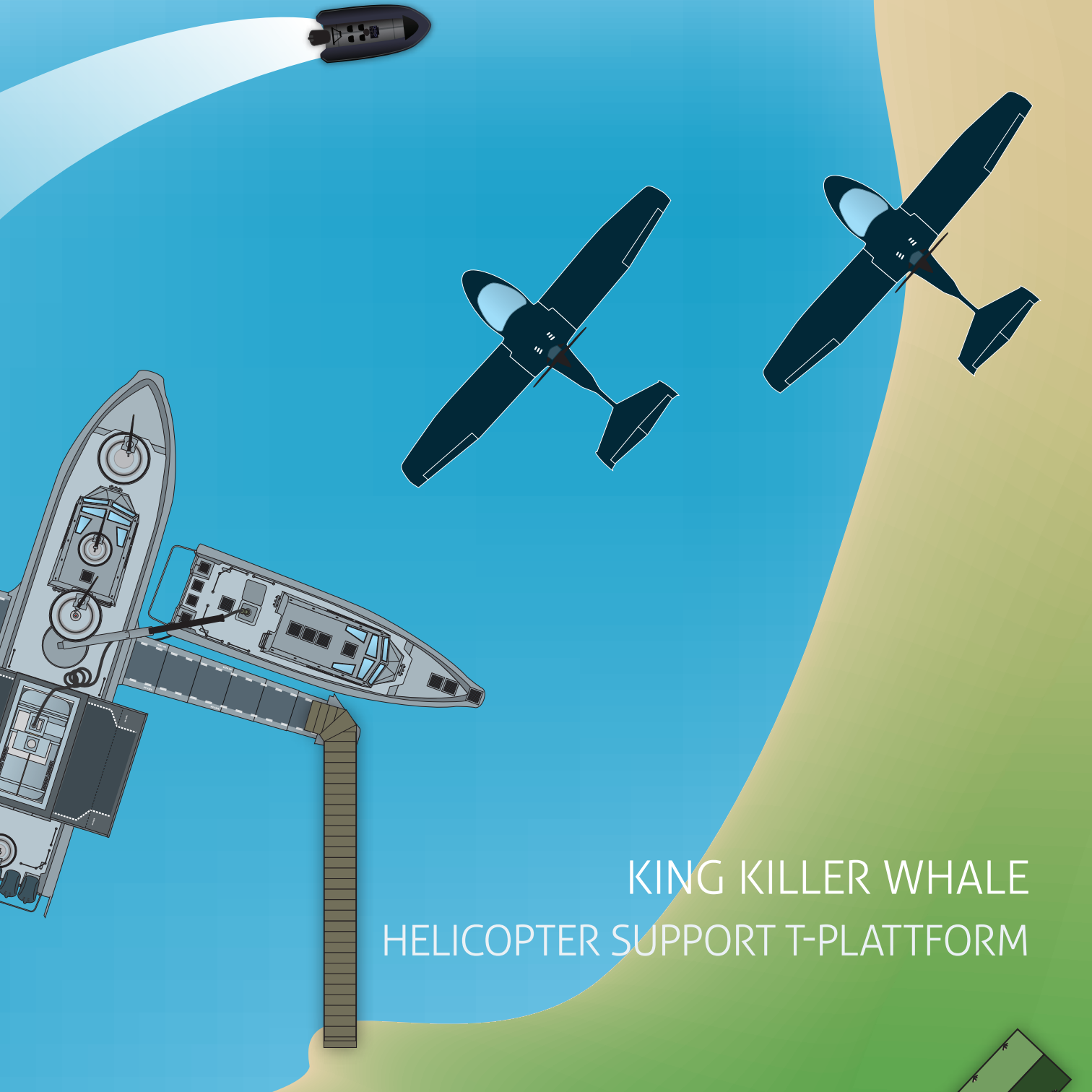

KING KILLER WHALE  
HELICOPTER SUPPORT T-PLATFORM





BULLET PROOF LEVEL III-VIII+ ANTI-EMP  
CABIN (HUMAN & ASSET PROTECTION  
PARAMOUNT)

TWO TO EIGHT MACHINE GUNS THAT CAN  
BE OPERATED BY NAVY PERSONNEL OR VIA  
A JOYSTICK AND VIDEO CAMERA



ANTI-EXPLOSION, ANTI-OXIDATION, ANTI-SLOSH, ANTI-ALGAE GROWTH, FUEL TANKS FILTERING TO INCREASE SPEED

SPECIAL BULLET LEVEL III-VIII+ PROOF ENGINE COVERING (PROTECTION COVERING TO REDUCE BULLET SHOTS)



# CERTIFICATES





**Architects  
Engineers  
Building  
Officials  
Section**

**JAA**



**CE**



**SOUTHWEST**



**National Fire Protection Association**  
The authority on fire, electrical and building safety

# LEGAL NOTICE

Copyrights TechnoKontrol Cat Global S.L. All Rights Reserved. The text, images, graphics, sound files, animation files, video files and their arrangement on TechnoKontrol Cat Global S.L. Internet sites are all subject to Copyright and other intellectual property protection. These objects may not be copied for commercial use or distribution, nor may these objects be modified or reposted to other sites. Some Technokontrol Internet sites also contain material that is subject to the copyright rights of their providers. All modifications of the web or publicity can be done as the corporation requires. All web and publicity information is not contractual but only information.

Product variations. Some of the product information, illustrations and images contained on this Internet site or all types of publicity may have been prepared for generic use on Technokontrol Internet sites maintained in different countries around the world. Consequently, some of the information and/or accessories which are not available in some countries or which, in order to satisfy local market demand or regulatory controls in such countries, may only be available in different specifications or configurations.

If you are interested in any product, alloy, services, options or accessory shown on the Internet site or publicity and are unsure of its availability or specification in your locality, you should contact TechnoKontrol Cat Global S.L. and/or a local authorized dealer for the relevant product, for information of current details in your locality.

## DISCLAIMER

We do not make representation that information and materials on this website and corporate publicity are appropriate for use in all jurisdictions available on the web, or that transactions, securities, products, instruments or services offered on this website or publicity are available or indeed appropriate for sale or use in all jurisdictions, or by all investors or other potential clients. Those who access this website or publicity do so on their own initiative, and are therefore responsible for compliance with applicable local laws and regulations. By accessing each site, the entrant has agreed that he/she has reviewed the website or publicity in its entirety including any legal or regulatory terms.

# AVISO LEGAL

## PROPIEDAD INDUSTRIAL E INTELECTUAL

Estos textos e imágenes, así como todo tipo de publicidad en cualquier formato es propiedad de TechnoKontrol Cat Global SL. Los derechos de Propiedad Intelectual y derechos de explotación y reproducción de esta Web y publicidad, de sus páginas, pantallas, la información que contienen, su apariencia y diseño, así como los vínculos ("hiperlinks") que se establezcan desde ella a otras páginas web de cualquier sociedad perteneciente al Grupo, son propiedad exclusiva de éste salvo que se especifique otra cosa. Todas las denominaciones, diseños y/o logotipos que componen esta página son marcas debidamente registradas. Cualquier uso indebido de las mismas por persona diferente de su legítimo titular podrá ser perseguido de conformidad con la legislación vigente. Los derechos de propiedad intelectual y marcas de terceros están destacados convenientemente y deben ser respetados por todo aquel que acceda a la Web y los folletos informativos. Solo para uso personal y privado se permite descargar los contenidos, copiar o imprimir cualquier página de esta Web. Queda prohibido reproducir, transmitir, modificar o suprimir la información, contenido o advertencias de esta Web sin la previa autorización escrita de TechnoKontrol Cat Global S.L. Toda la información expuesta en la página web o en cualquier tipo de formato publicitario es únicamente informativo y no constituye ninguna obligación contractual.

# DROITS D'AUTEUR

*Copyright TechnoKontrol Cat Global S.L.. Tous droits réservés. Tous les textes, images, graphiques, sons, vidéo et animations ainsi que leur arrangement ou disposition sont protégés au titre du droit d'auteur et aux autres lois relatives à la protection de la propriété intellectuelle. Ils ne peuvent être ni modifiés, ni copiés à des fins commerciales ou à des fins de reproduction, ni utilisés sur d'autres sites web.*

*Marques commerciales. En l'absence d'indication contraire, toutes les marques mentionnées sur les pages internet de TechnoKontrol sont des marques déposées par TechnoKontrol Cat Global S.L. et protégées sur un plan légal. Cela concerne en particulier les noms de produits ou services ainsi que tous les logos et emblèmes du groupe TechnoKontrol Cat Global .S.L.*





**TECHNOKONTROL**

Ms. L. Cañada

C.E.O.

[lcanada@technokontrol.com](mailto:lcanada@technokontrol.com)

Tel +(34) 698 893 269

**SALES**

Mr. David Doyle

[info@technokontrol.com](mailto:info@technokontrol.com)

[www.technokontrol.com](http://www.technokontrol.com)

Ms. Sonia Martín

[sales@technokontrol.com](mailto:sales@technokontrol.com)

Tel 902 002 005

Fax 902 002 006