



MILITARY MARITIME

Products and services insured by



TechnoKontrol is a member of the



National Fire Protection Association
The authority on fire, electrical, and building safety

INDEX

4	King Shark I - Light Armoured Patrol Vessel
8	King Shark II - Heavy Armoured Patrol Vessel
10	King Shark III - Aircraft Carrier
20	King Shark IV - Submarine Carrier
24	King Shark V - Assault Troop Carrier
28	King Shark VI - Fuel Carrier
32	King Shark VII - Logistical Cargo Carrier
34	King Shark VIII - Plasma Fusion Gunship
38	King Shark IX - Missile Launcher
40	King Shark X - Emergency/Hospital
42	King Shark XI - Helicopter Carrier
48	King Shark XII - Fire Services/Heliport
52	King Shark XIII - Fire Services Long Ladder/Unmanned Long Ladder
60	King Shark XIV - Long Range Radar
64	King Killer Whale
68	King Killer Whale - Heavy Helicopter Carrier
72	King Killer Whale - Mega Multi-Use Vessel
76	King Killer Whale - Long Range Radar
80	King Killer Whale - High Speed Patrol Vessel Carrier
86	King Killer Whale - Heavy Fuel Carrier
90	King Killer Whale - Plasma Fusion Gunship
94	King Killer Whale - Aerial-Maritime-Terrestrial Refueling Vessels
102	Vessel Traffic Services (VTS) & Automatic Identification Systems (AIS-RAIS)
104	Maritime & Submarine Technologies
106	Safe Haven Aero / Land / Naval Mobile Bases
108	Oil Tankers, Barges, Ports & Vessels Safety, Security & Efficiency
110	Helipads / Heliports

KING SHARK





KING SHARK I LIGHT ARMoured PATROL VESSEL

The King Shark I is a light patrol vessel perfect for rivers, river deltas, coastal control, etc.



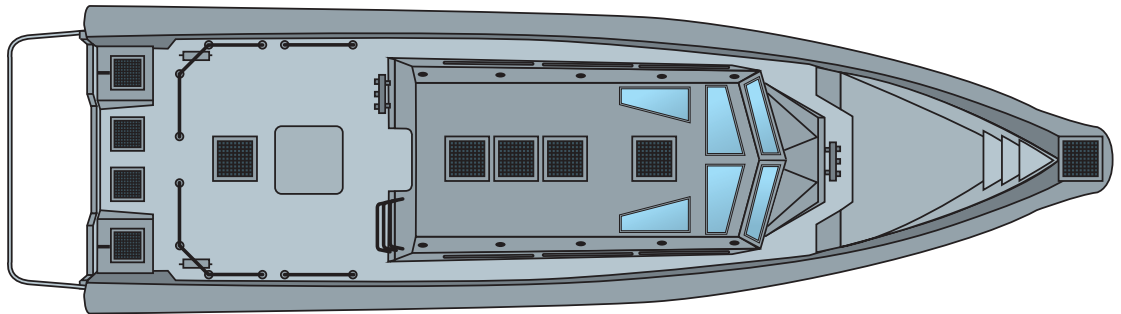
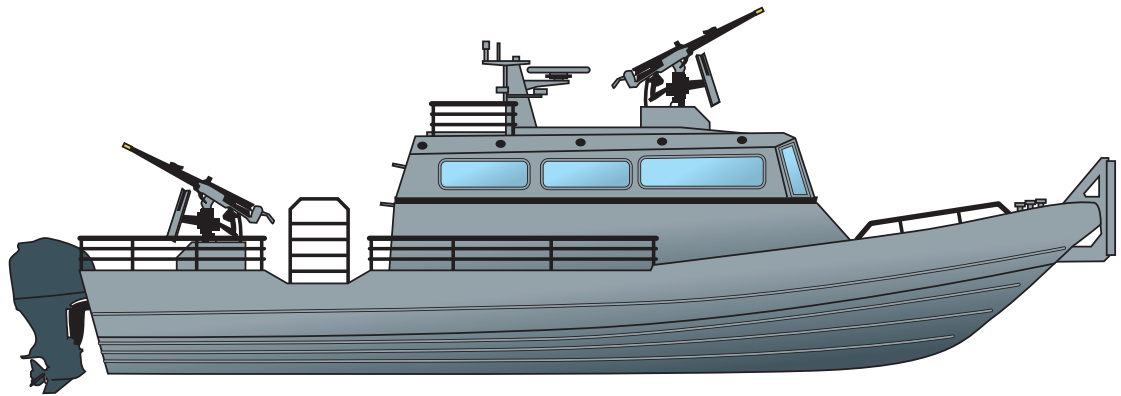

Technokontrol © Copyright. All Rights Reserved. All Designs & Applied Technologies Patented

CHARACTERISTICS & MORE INFORMATION

<http://technokontrol.com/en/products/king-shark-V-I.php>

KING SHARK II

HEAVY ARMoured PATROL VESSEL

The King Shark II Is a larger type patrol vessel. It moves fast at sea but it also have great operational range and heavy fire power.

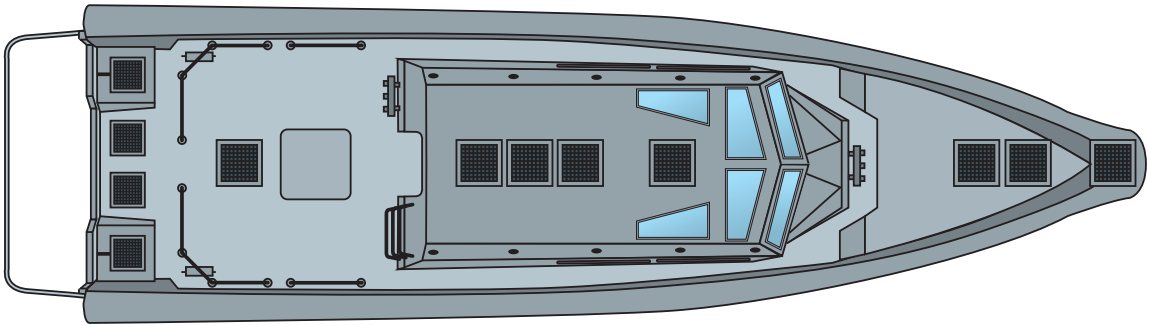
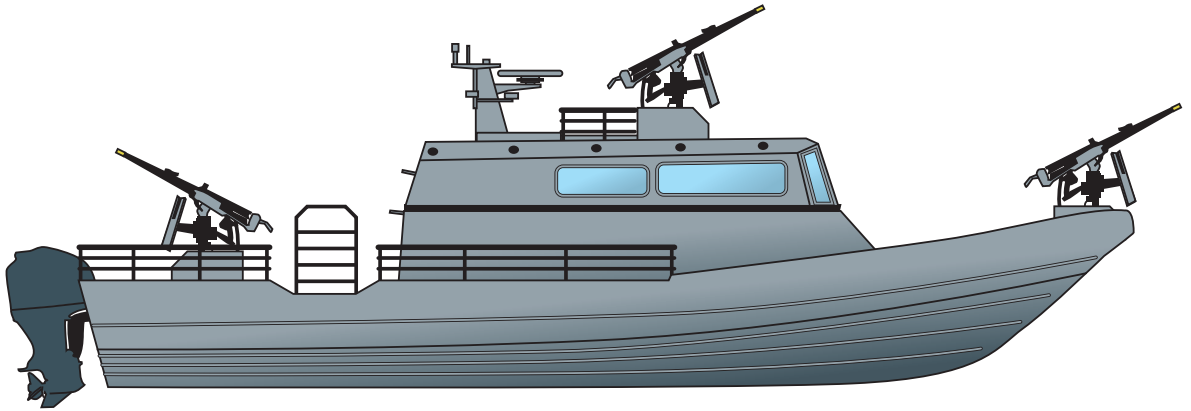

Technokontrol © Copyright. All Rights Reserved. All Designs & Applied Technologies Patented

CHARACTERISTICS & MORE INFORMATION

<http://technokontrol.com/en/products/king-shark-V-II.php>

KING SHARK I & II





KING SHARK III AIRCRAFT CARRIER

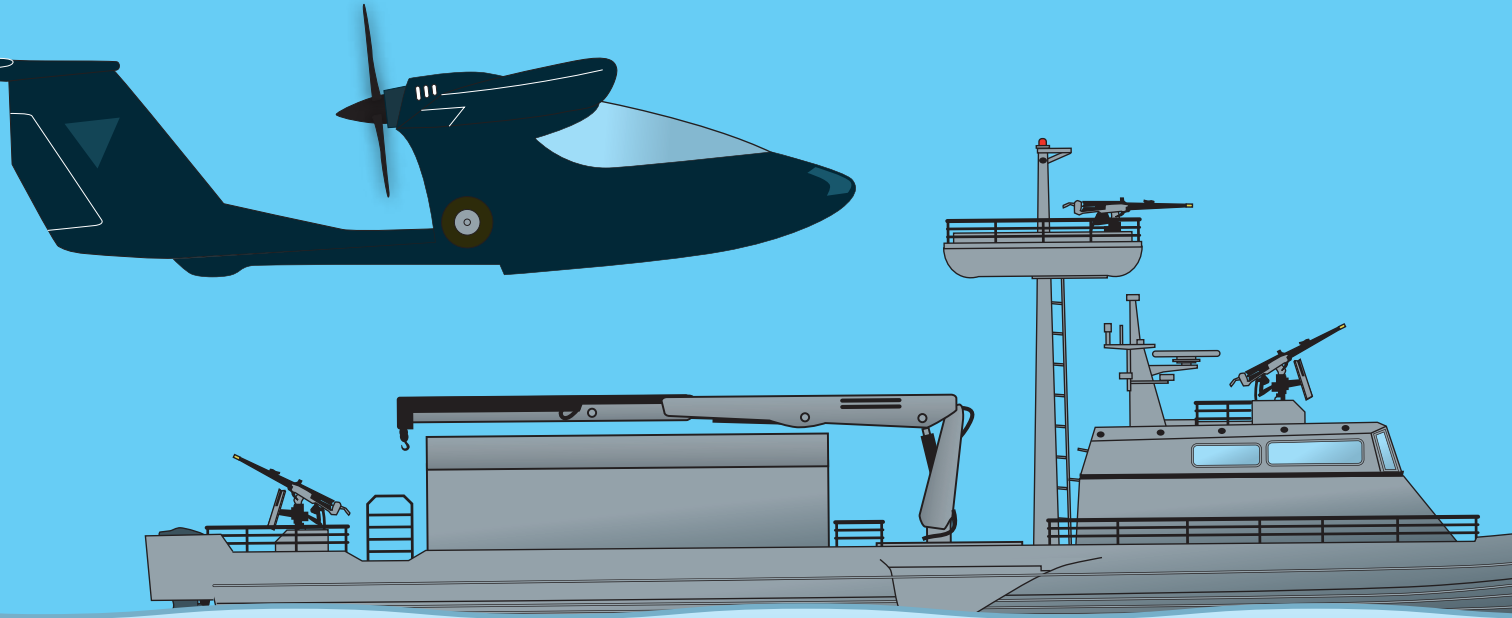

An ideal vessel to carry its own Eagle Eye Aircraft for long range surveillance of over 1,500 km per flight, and to which we can mix sea and aerial operations at a fraction of the cost of normal navy/military operational vessels. Clients will be able to select any Eagle Eye Aircraft depending on their operational needs; from surveillance to defence or to research activities.

CHARACTERISTICS & MORE INFORMATION

<http://technokontrol.com/en/products/king-shark-V-03.php>

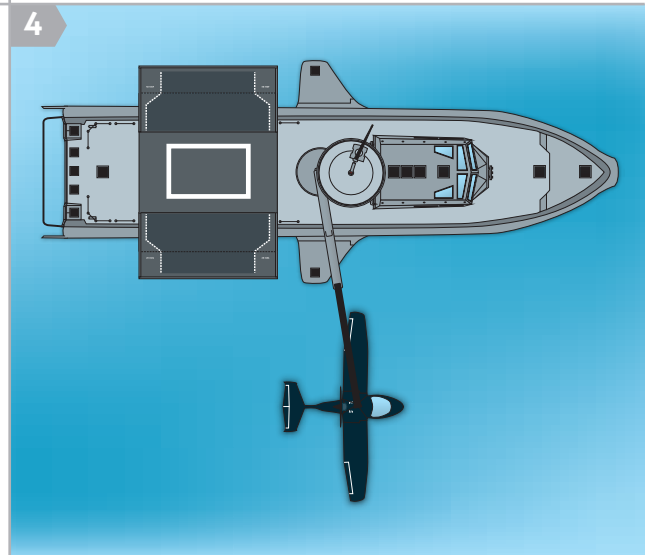
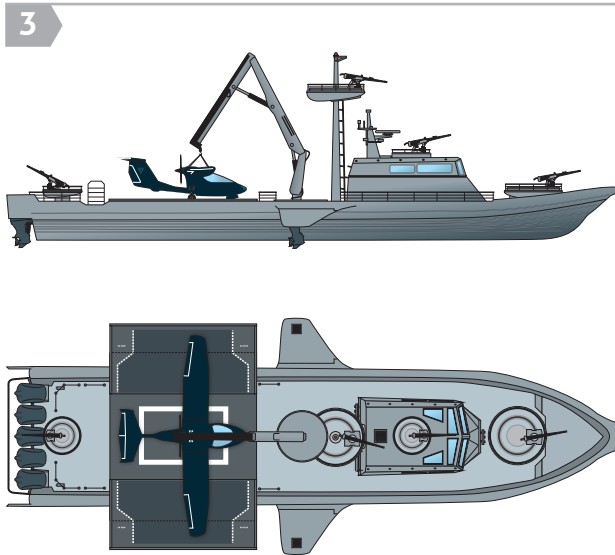
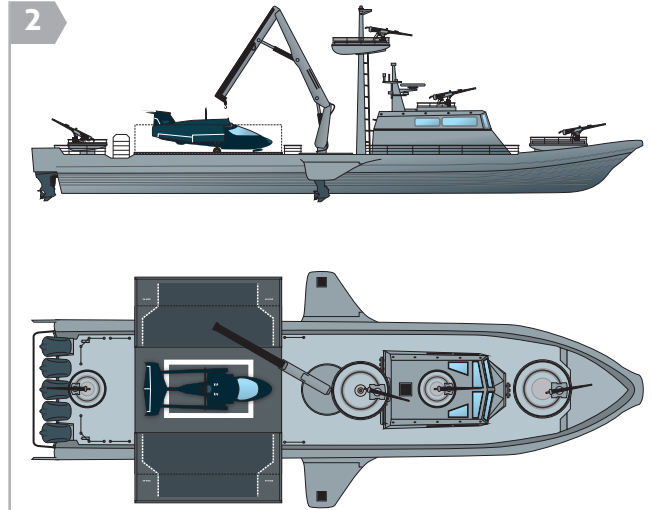
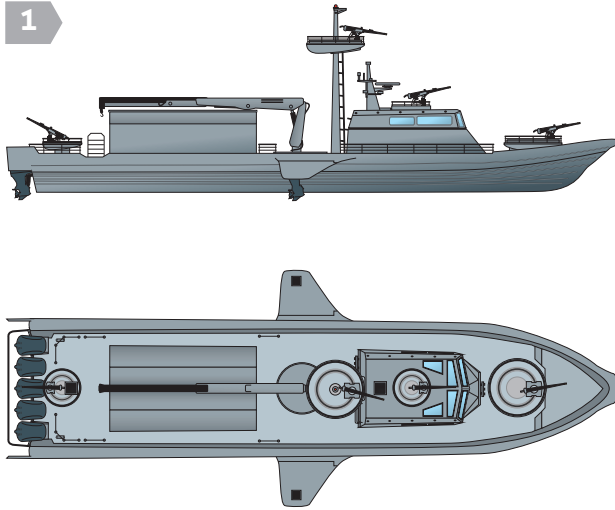

AILERON EXTENSION PLATFORMS SPEED & BALANCE

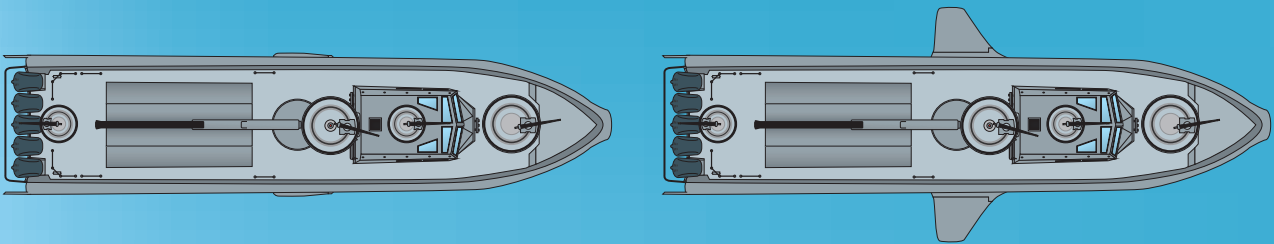

Extendible "Aileron Extension Platforms" to attach different types of vessels and shore docking.

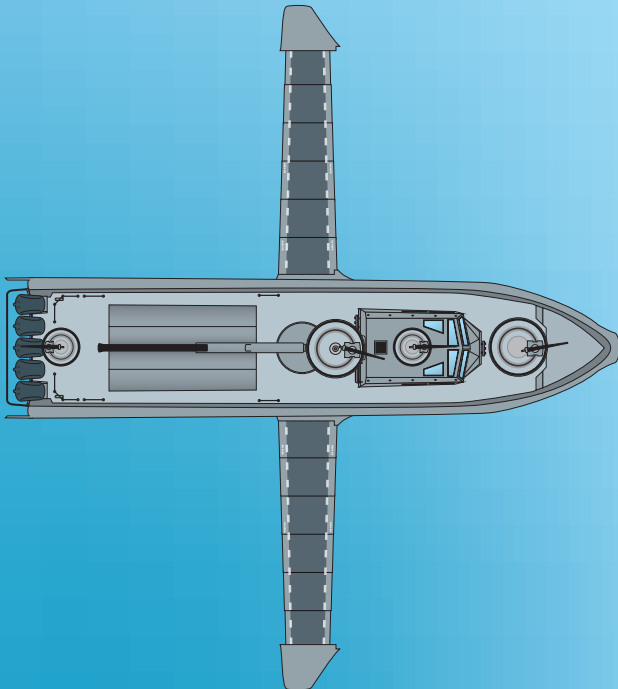
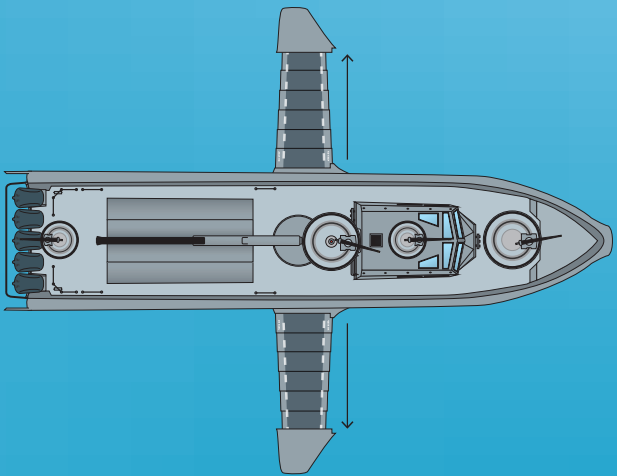

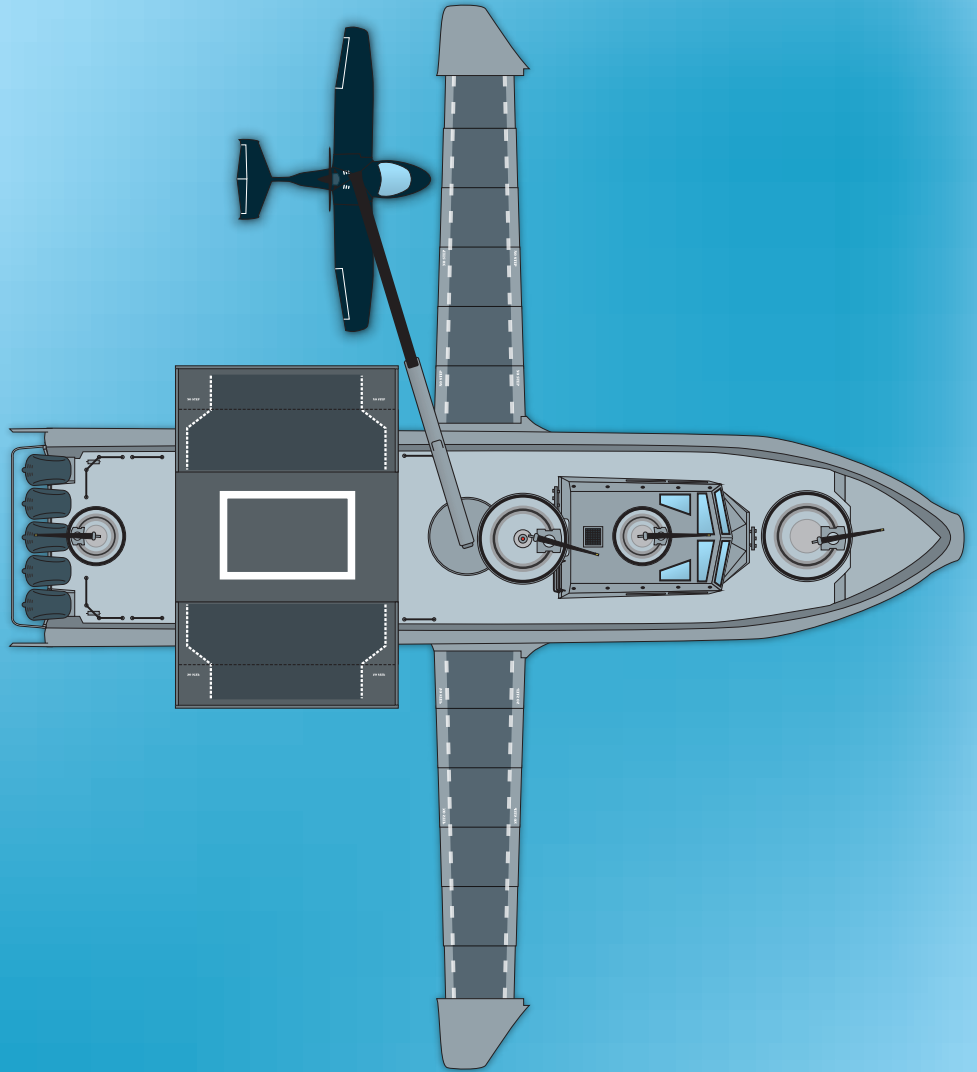

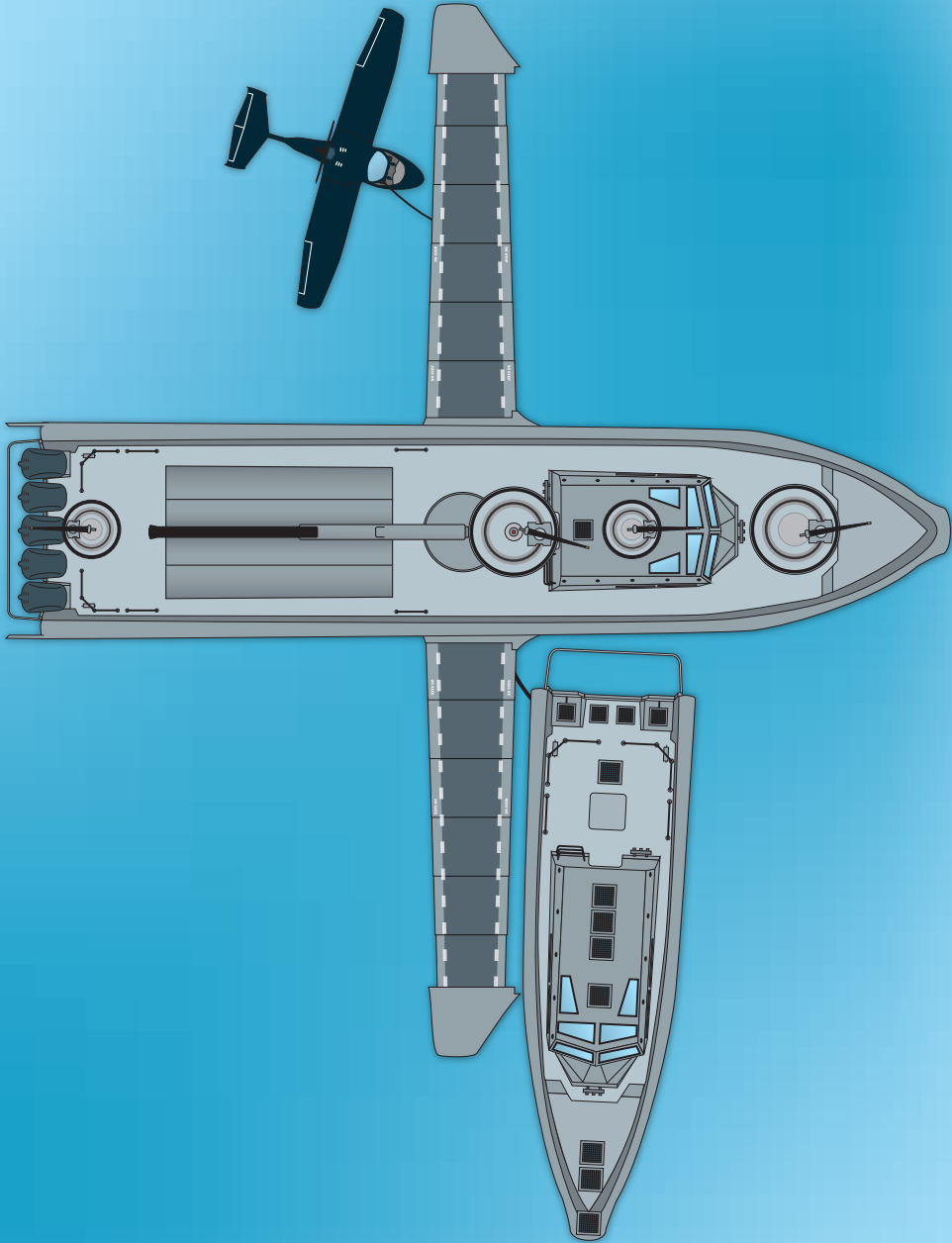

An aerial photograph of a large ship's deck, likely a helicopter carrier, showing numerous small boats and a helicopter wing in the foreground. The text 'KING SHARK III & EAGLE EYE' is overlaid in white on the left side of the image.

KING SHARK III & EAGLE EYE



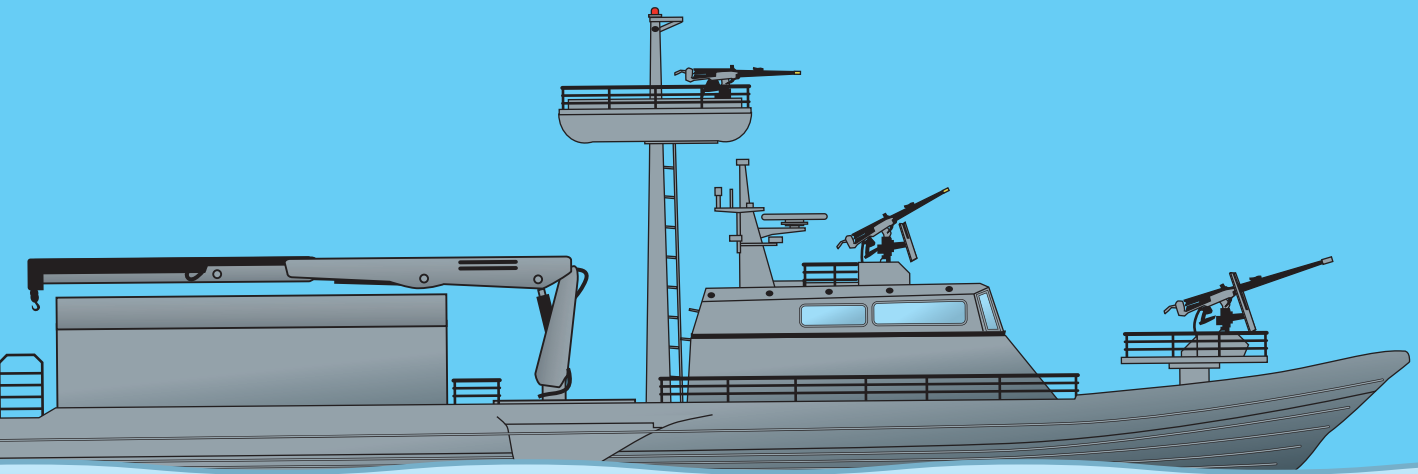

KING SHARK IV SUBMARINE CARRIER

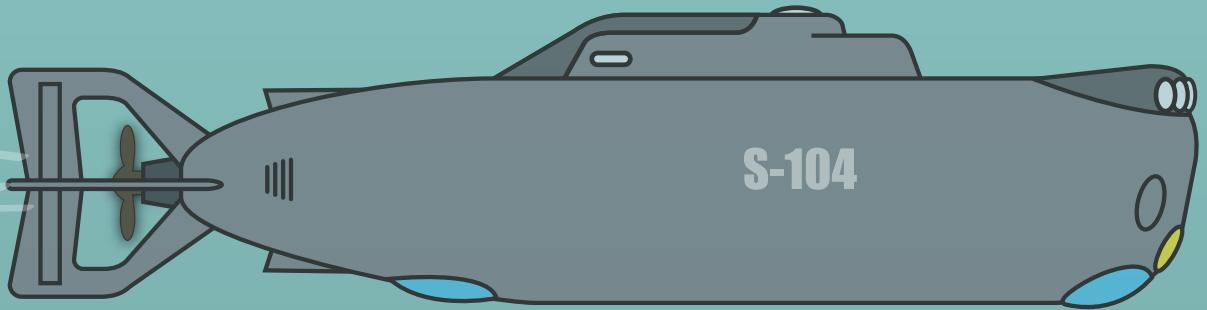

These vessels have the capacity to carry and to launch submarines, mines and information/research based sonobuoys in rivers and at sea for tracking operations of other vessels, ships, submarines, piracy movements, etc.

CHARACTERISTICS & MORE INFORMATION

<http://technokontrol.com/en/products/king-shark-V-04.php>

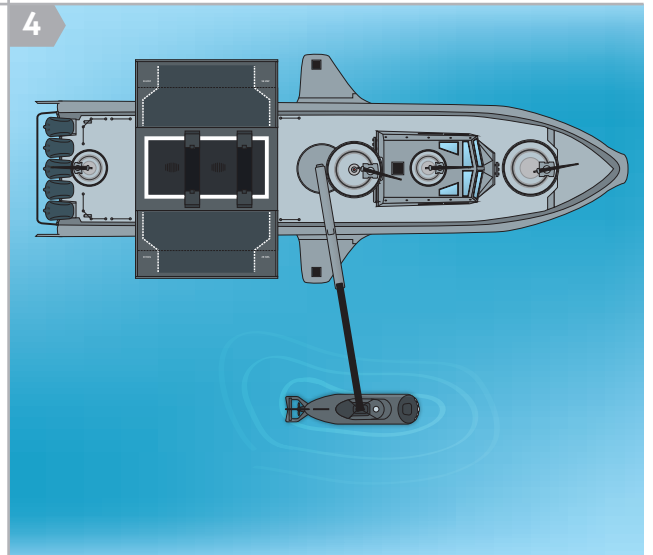
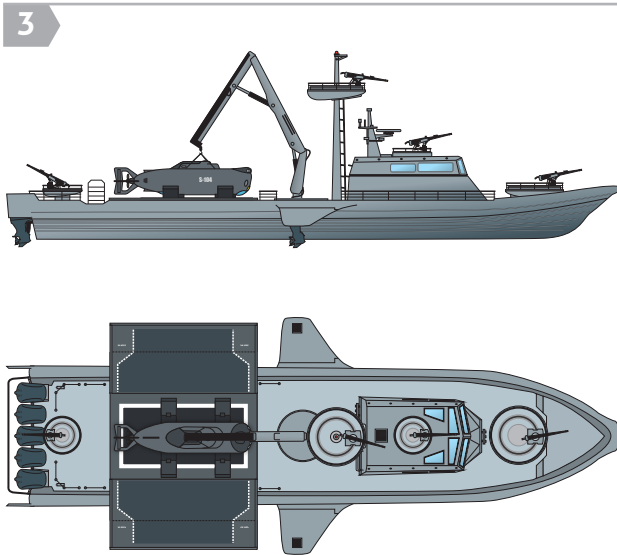
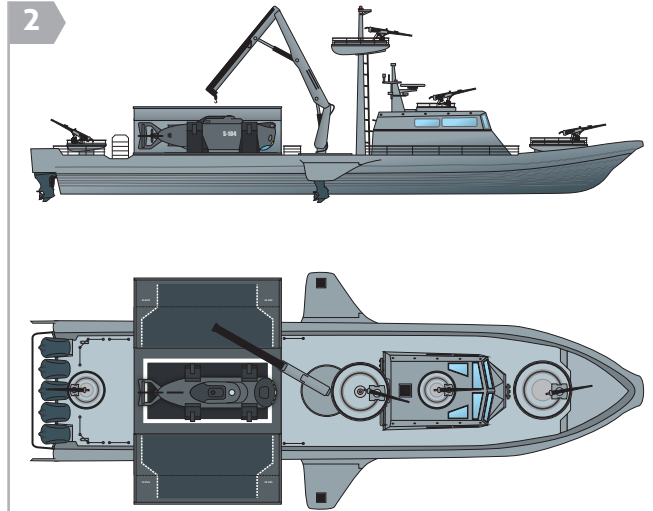
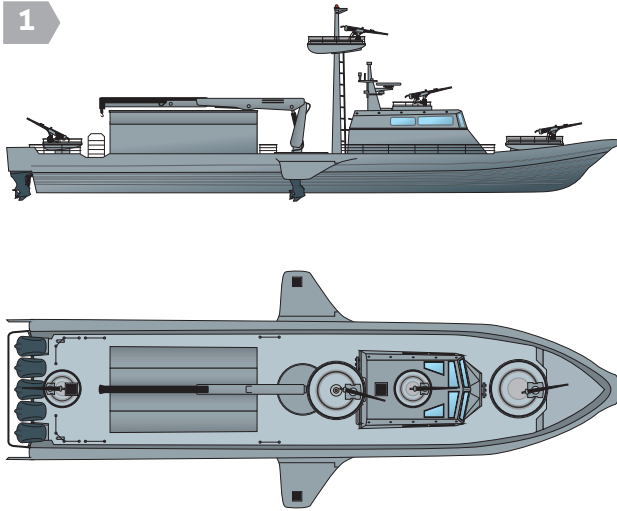





KING SHARK V ASSAULT TROOP CARRIER

Especially designed as a fully high speed, well protected and special operations troop carrier of up to 24-30 troops.

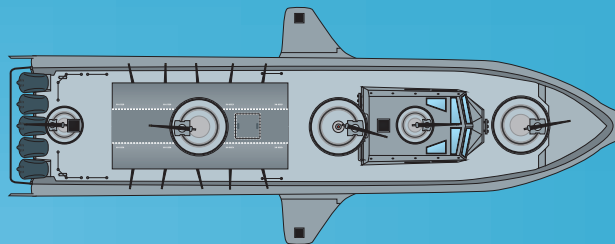
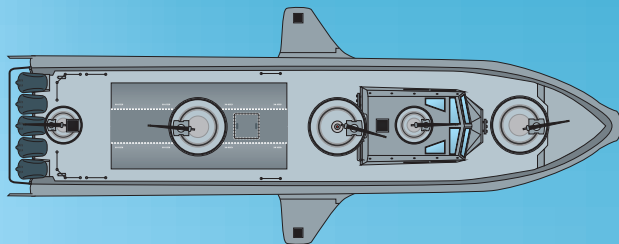
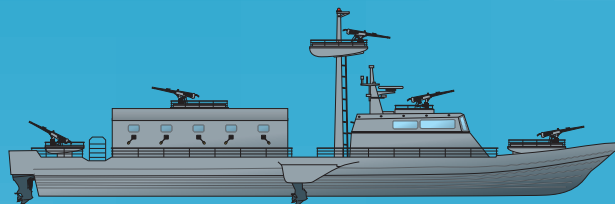
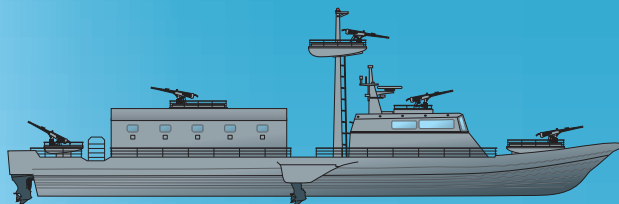

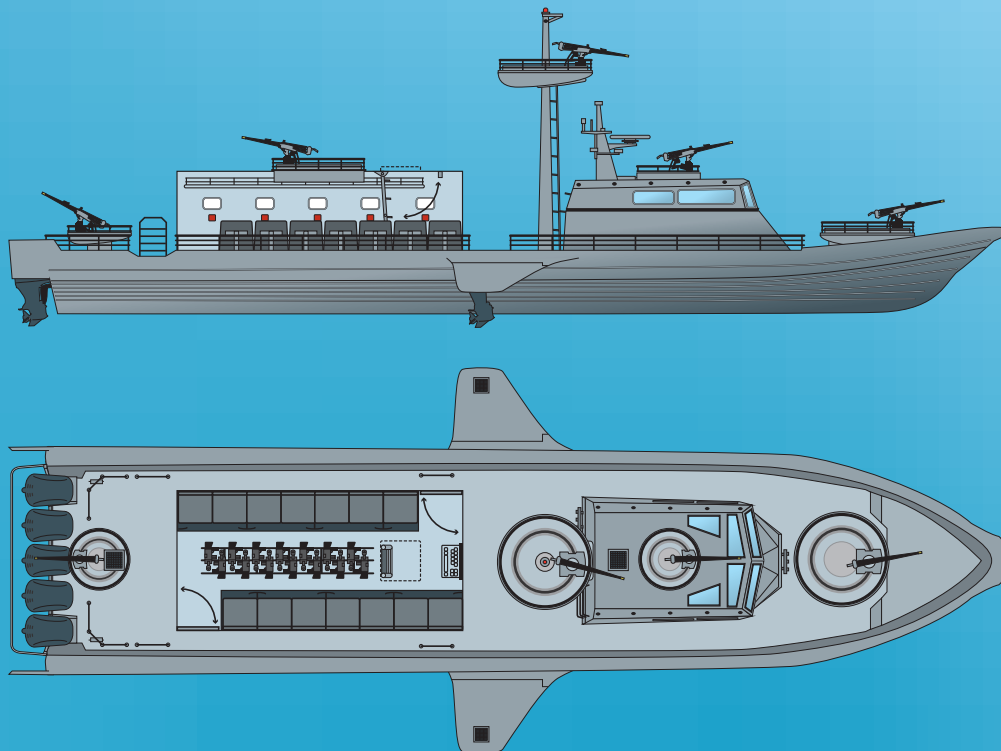

CHARACTERISTICS & MORE INFORMATION

<http://technokontrol.com/en/products/king-shark-V-05.php>



KING SHARK V



KING SHARK VI FUEL CARRIER

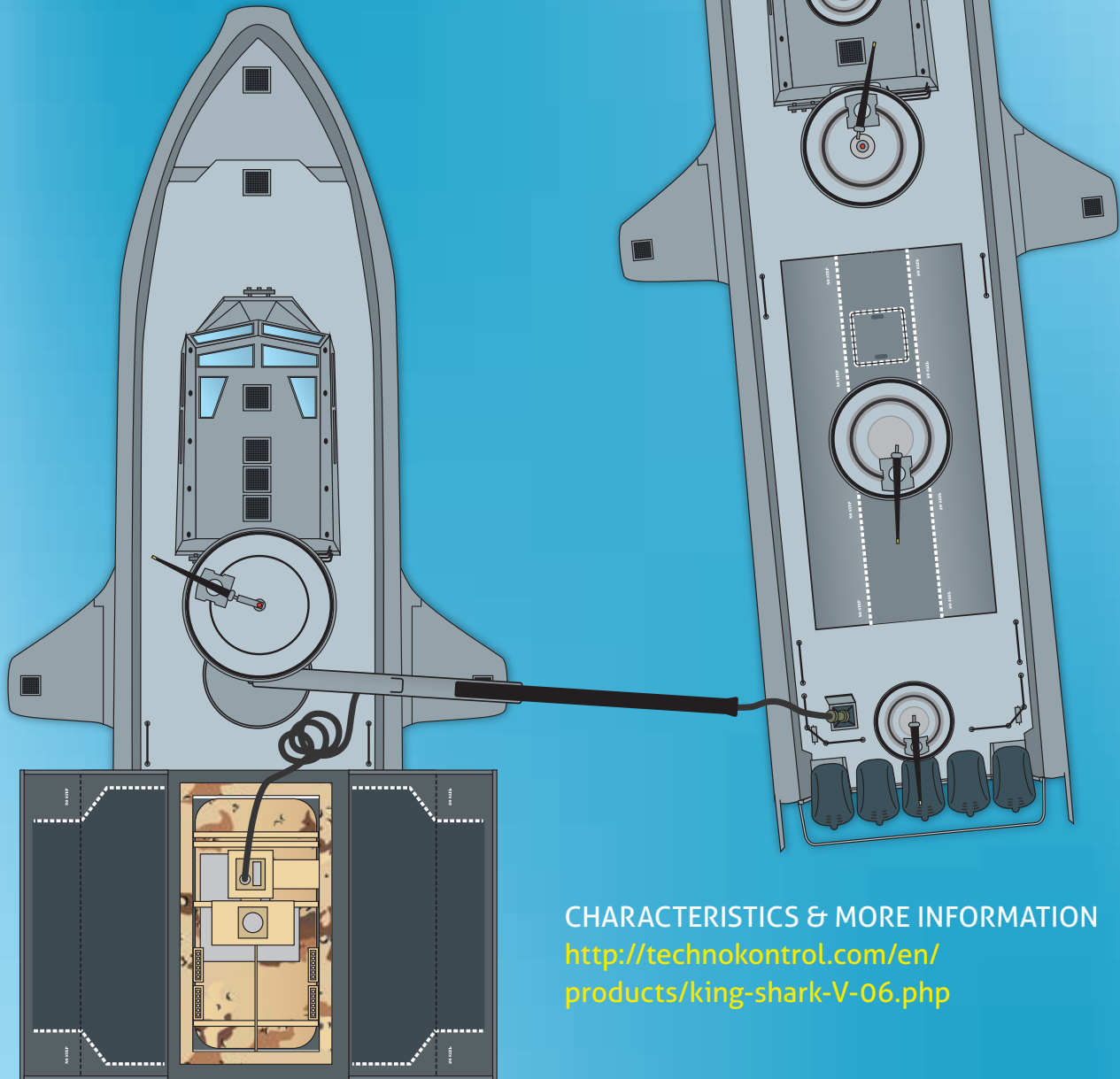

CHARACTERISTICS & MORE INFORMATION
[http://technokontrol.com/en/
products/king-shark-V-06.php](http://technokontrol.com/en/products/king-shark-V-06.php)

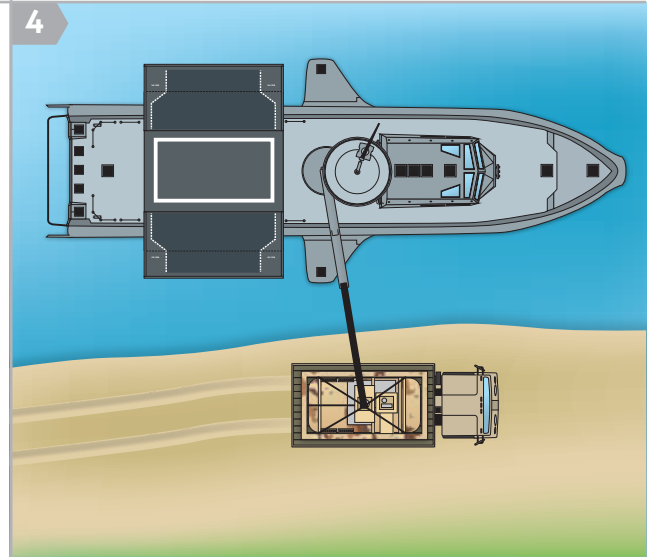
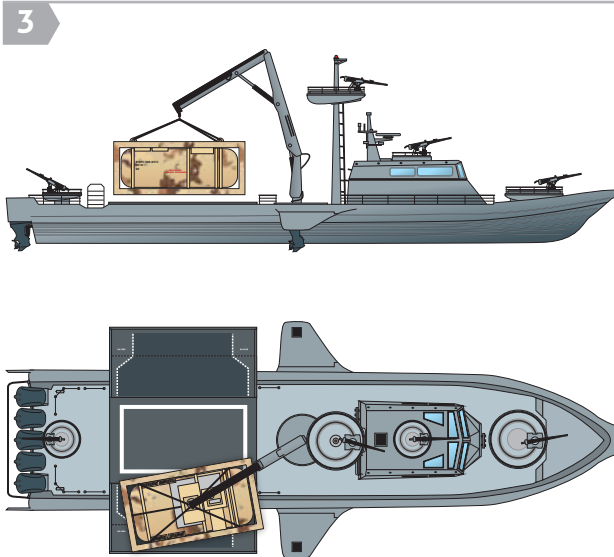
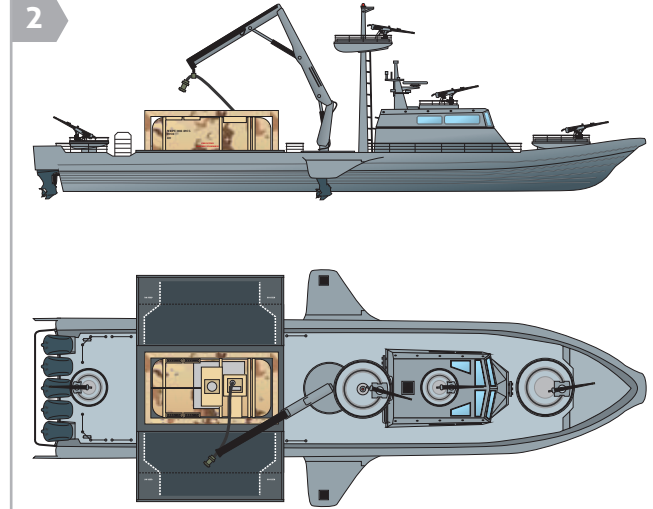
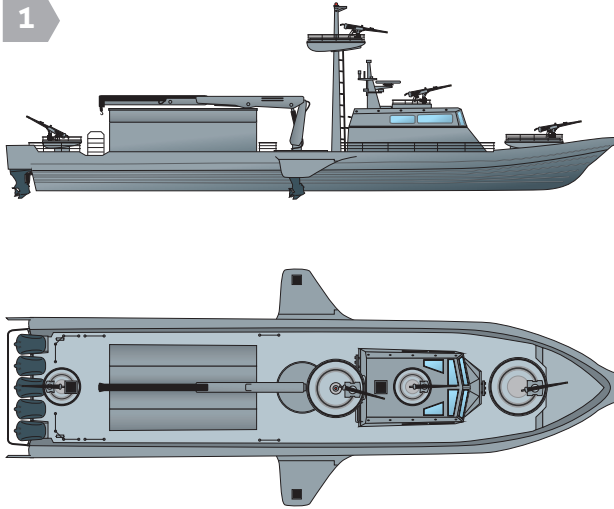

Heavy duty vessel for all types of logistical use and especially for refueling other King Sharks at sea or at extreme locations where this can't be done with normal ground logistics as ports, harbours, fuels vessels, etc.





KING SHARK VII

LOGISTICAL CARGO CARRIER

For all types of logistical use and especially for transporting supplies to other King Sharks at sea or at extreme locations where this can't be done with normal ground logistics as ports, harbours, fuels vesels,etc. Including their secretive use for refueling/supplying special or long term law enforcement, navy or military observation, surveillance, defence or attack operations without depending on other personell or civilians, and allowing full cover operations to continue for long periods of time.



CHARACTERISTICS & MORE INFORMATION

<http://technokontrol.com/en/products/king-shark-V-07.php>

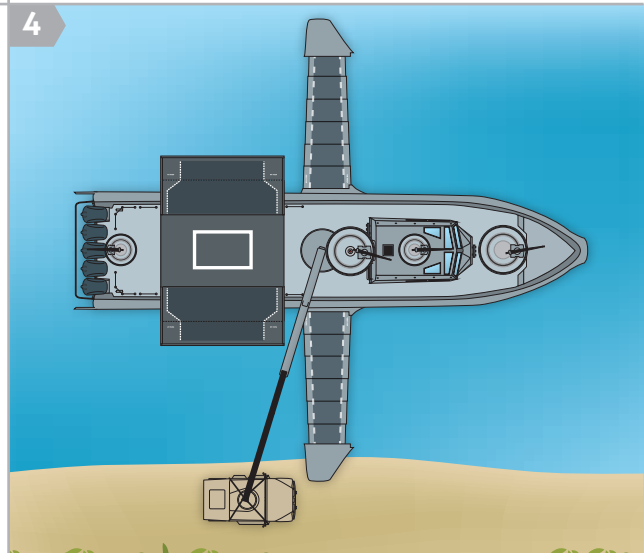
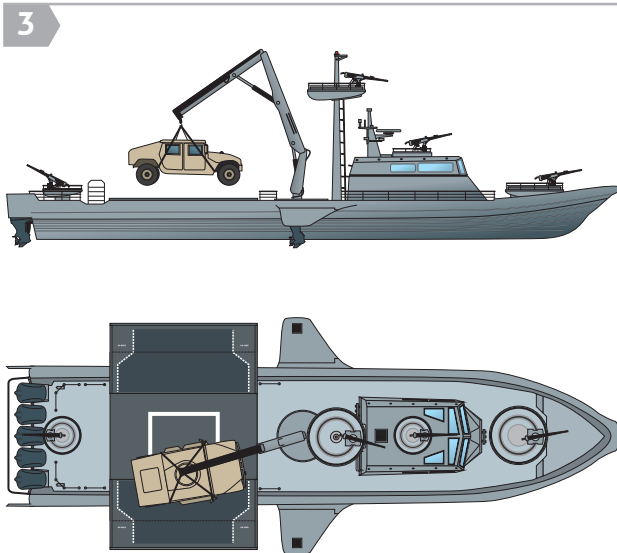
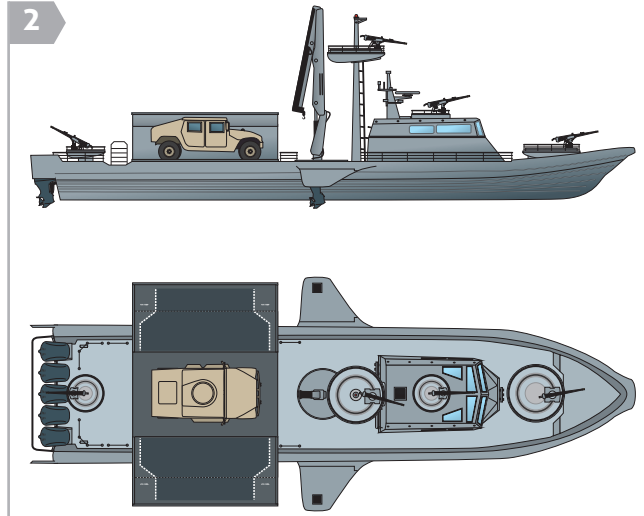
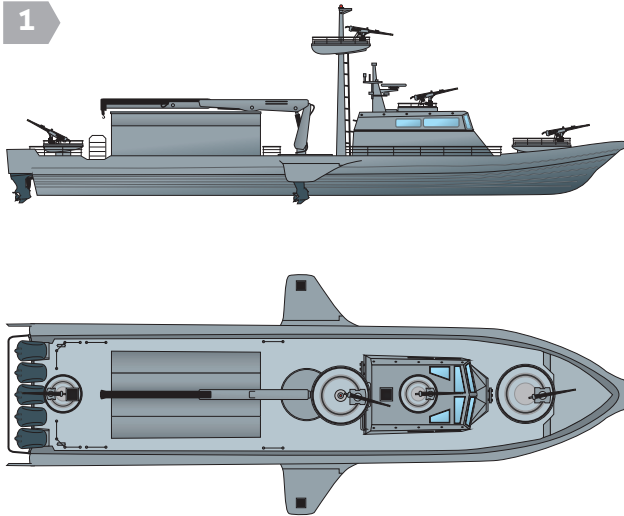

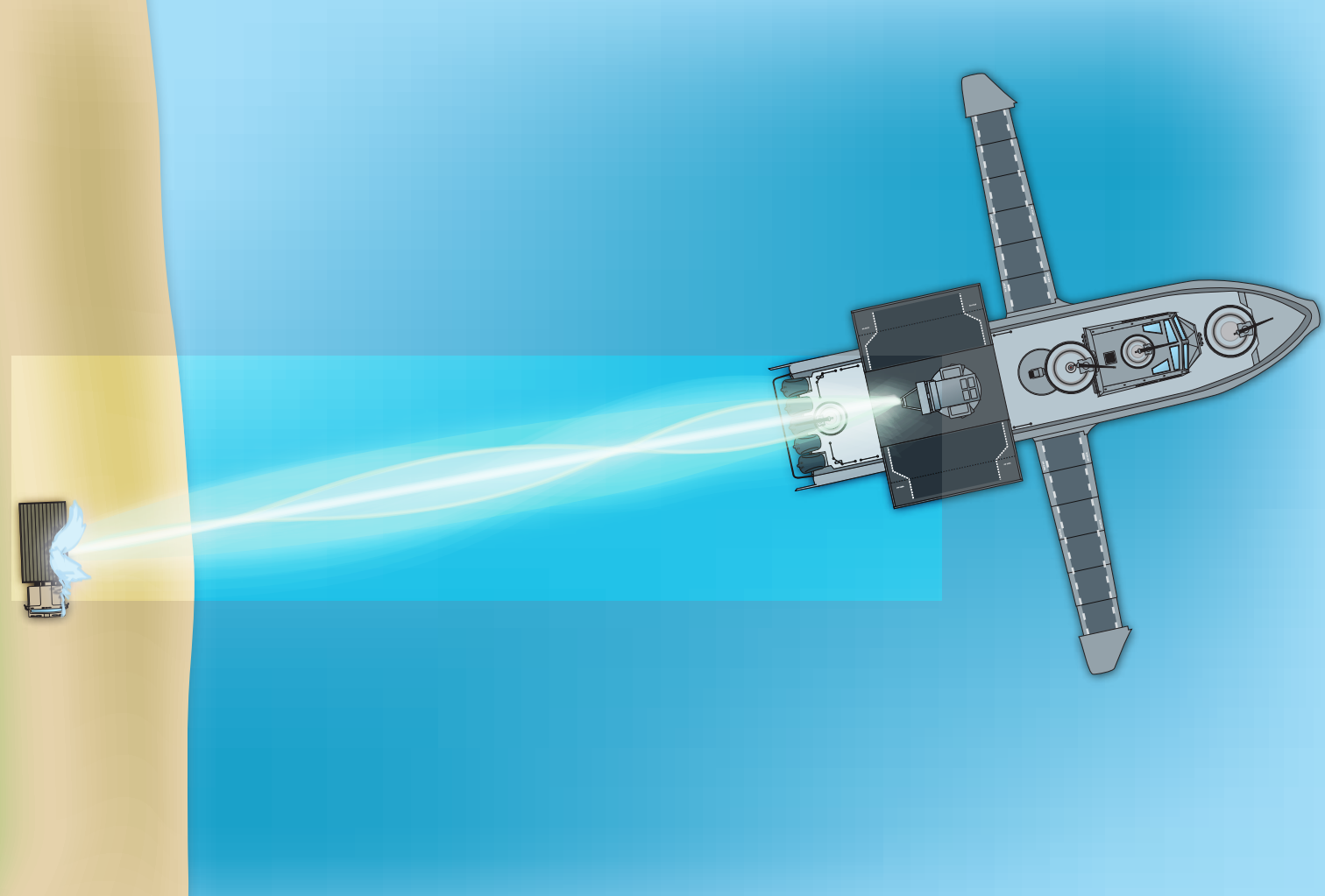

KING SHARK VIII PLASMA FUSION GUNSHIP

CHARACTERISTICS & MORE INFORMATION

<http://technokontrol.com/en/products/king-shark-V-08.php>

1

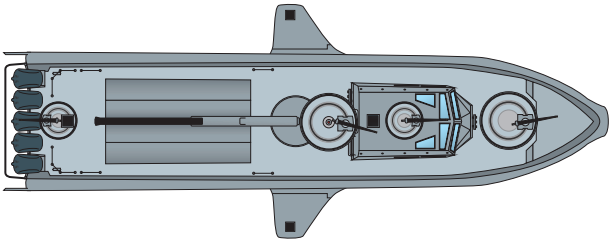
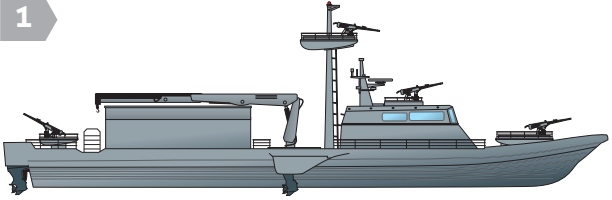

2

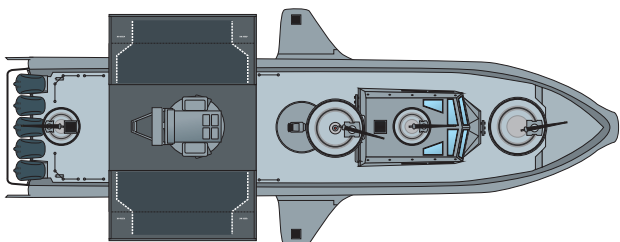
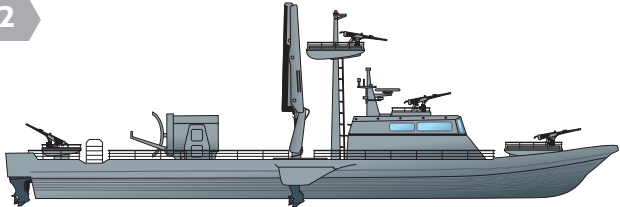

3

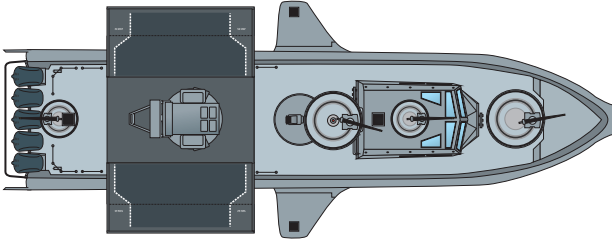
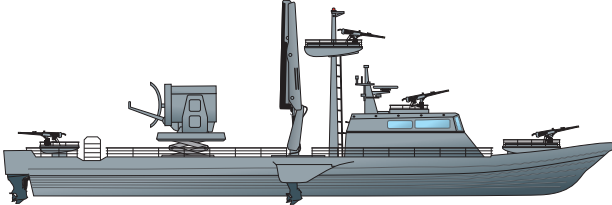

4

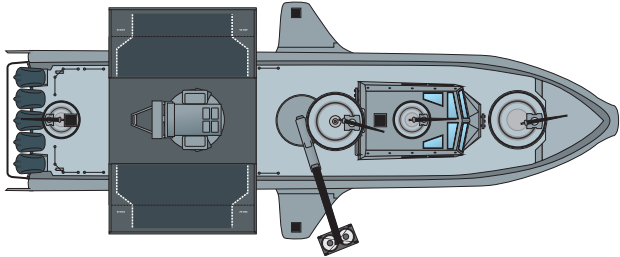
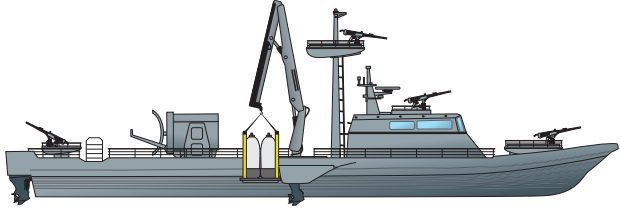





KING SHARK IX MISSILE LAUNCHER



CHARACTERISTICS & MORE INFORMATION

<http://technokontrol.com/en/products/king-shark-V-09.php>

1

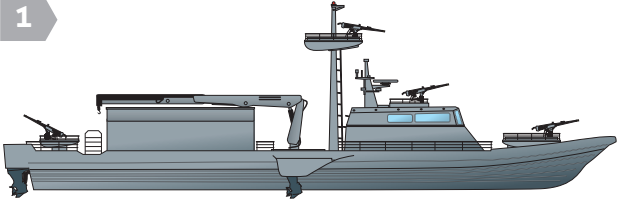

2

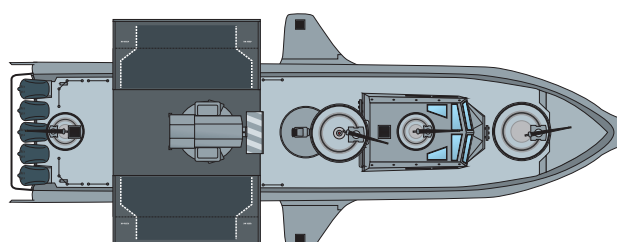
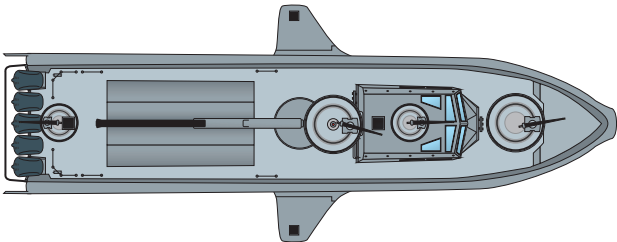
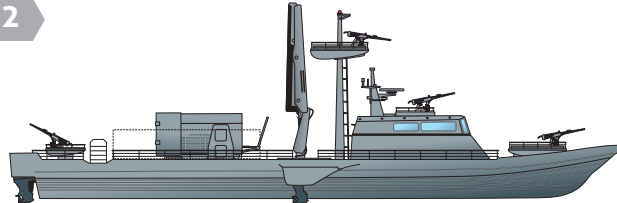

3

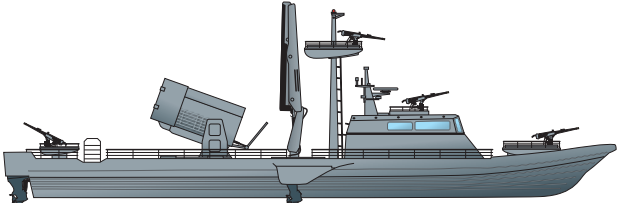

4

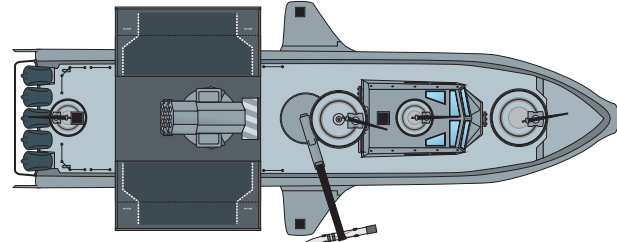
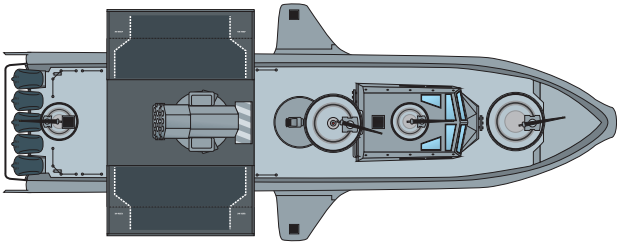
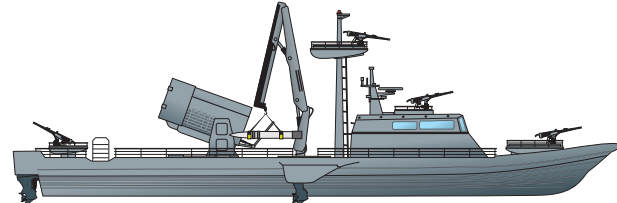

KING SHARK X EMERGENCY / HOSPITAL

Hospital vessel with extendible
heliport to easily manage load/unload
manouvers.



CHARACTERISTICS & MORE INFORMATION

<http://technokontrol.com/en/products/king-shark-V-10.php>

1

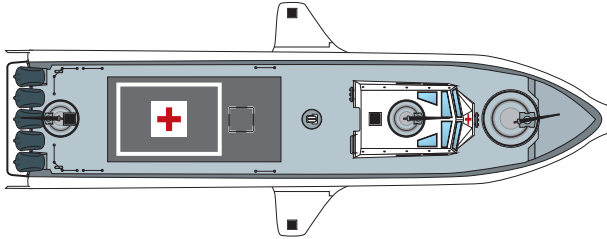
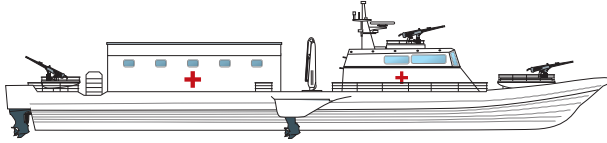

2

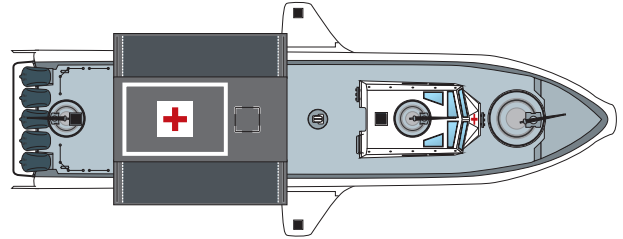
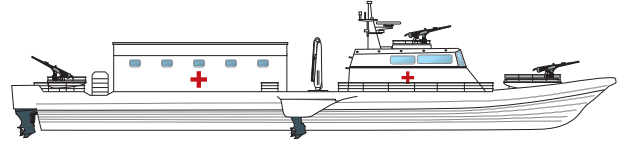

3

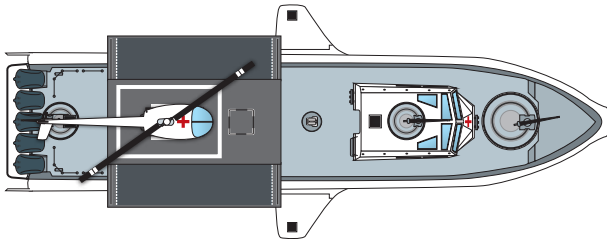
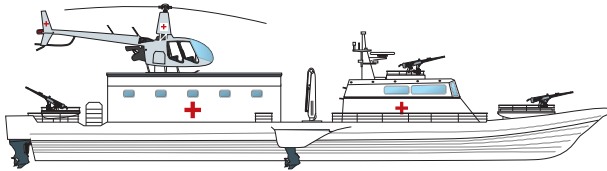

4

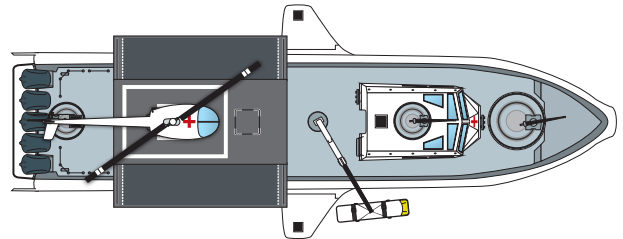
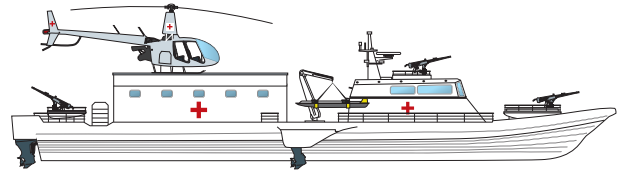

KING SHARK XI HELICOPTER CARRIER

Sea/river manouver-capable vessel with a folded helicopter inside for rapid deployment and easy access to any place.





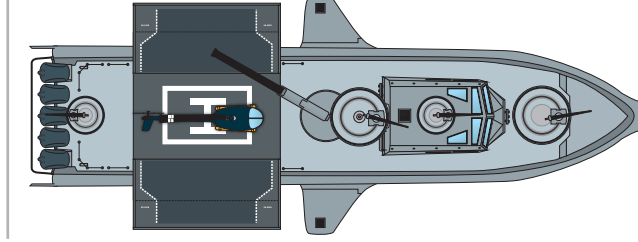
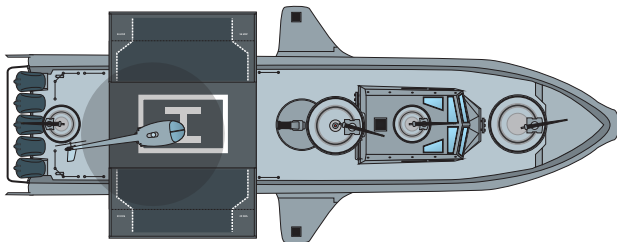
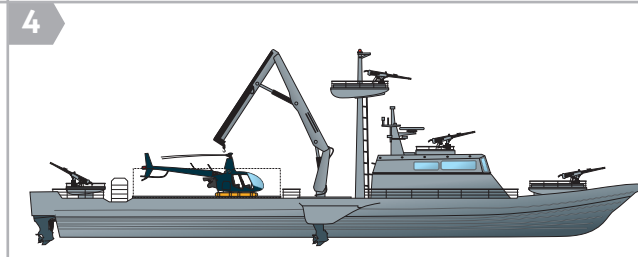
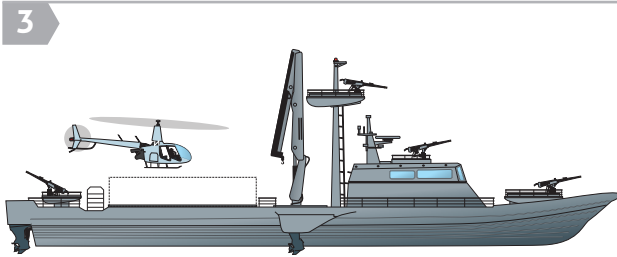
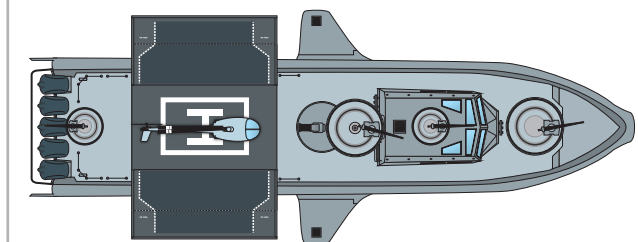
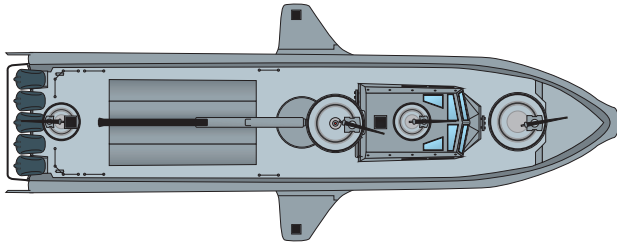
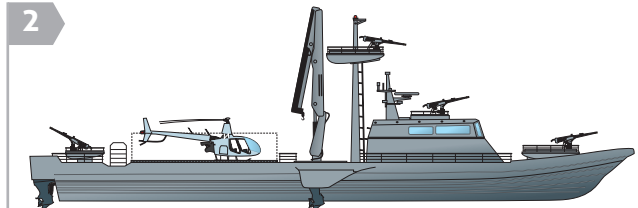
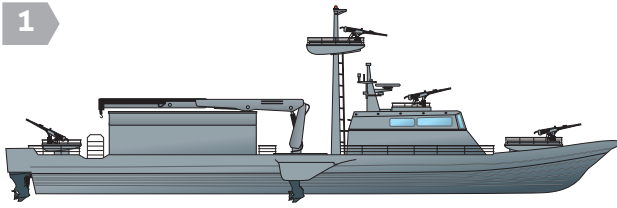

Technokontrol © Copyright. All Rights Reserved. All Designs & Applied Technologies Patented

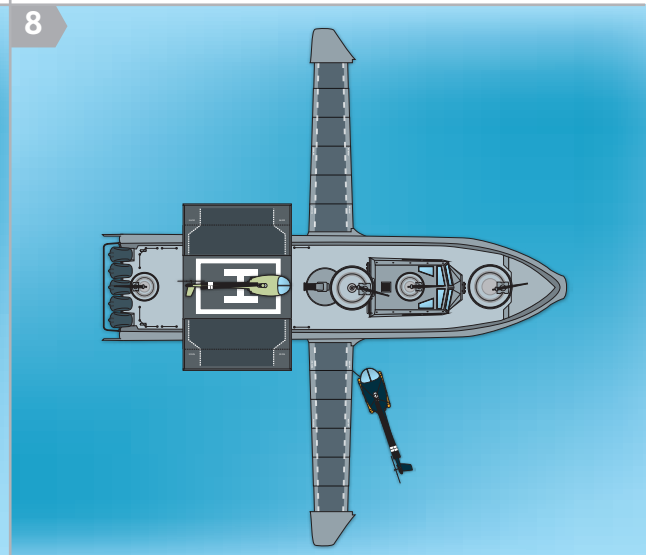
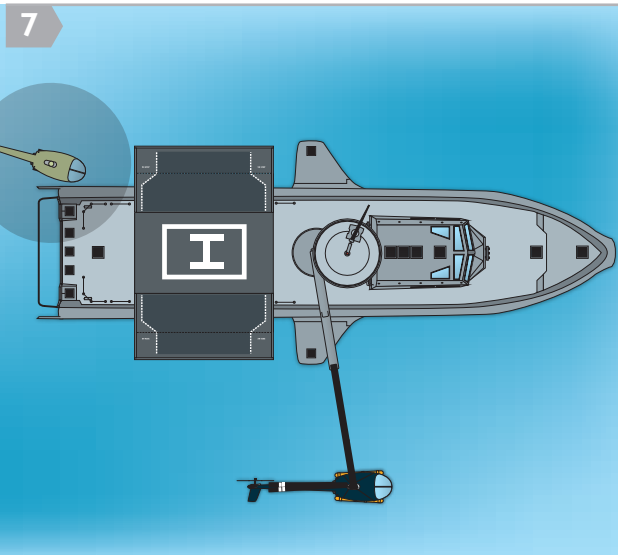
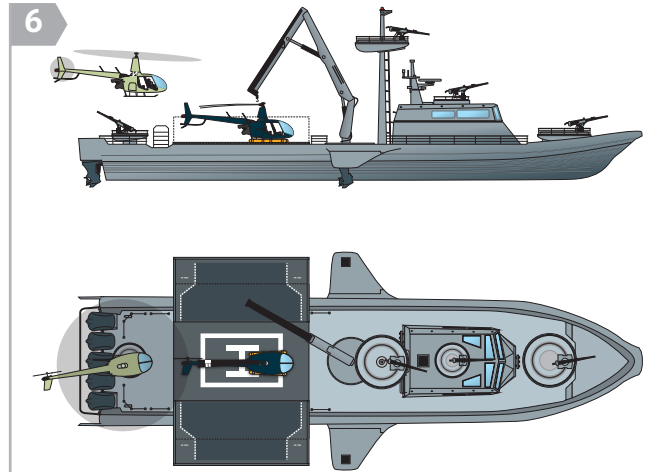
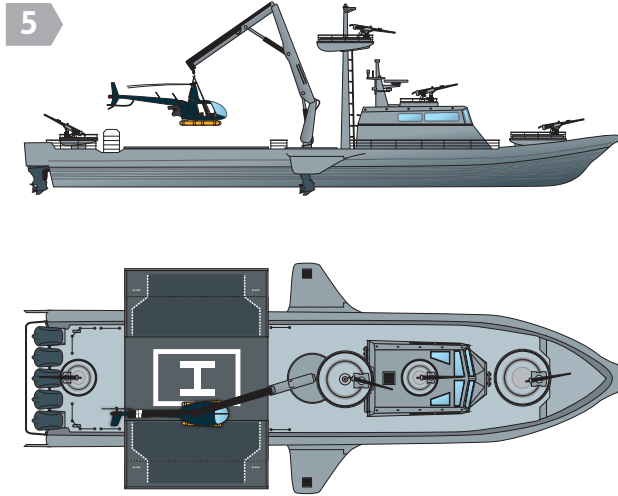

CHARACTERISTICS & MORE INFORMATION
<http://technokontrol.com/en/products/king-shark-V-11.php>







KING SHARK XII FIRE SERVICES / HELIPORT

Fire services vessel with ecological foam containers and extendible heliport
to easily manage load/unload manouvers



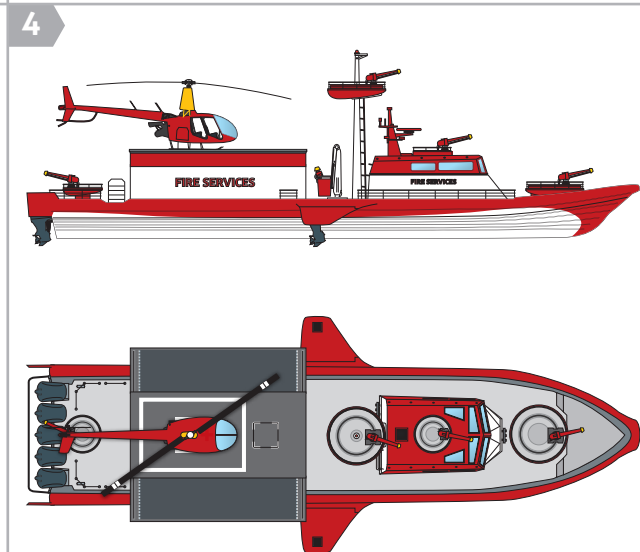
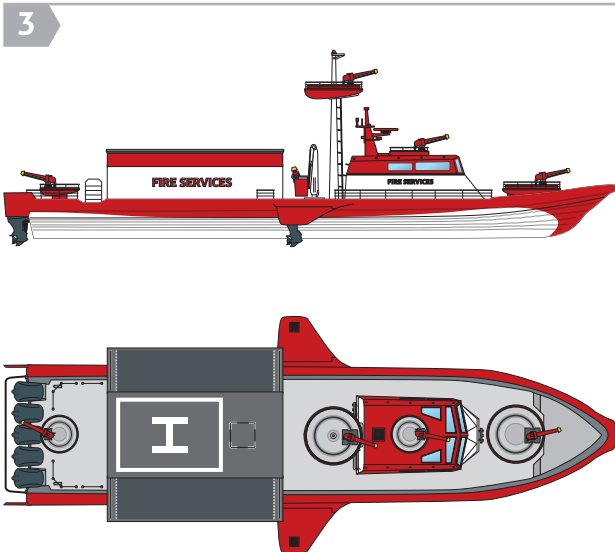
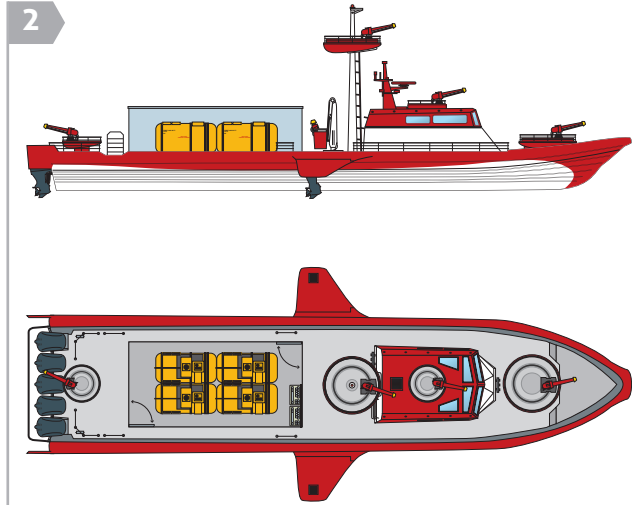
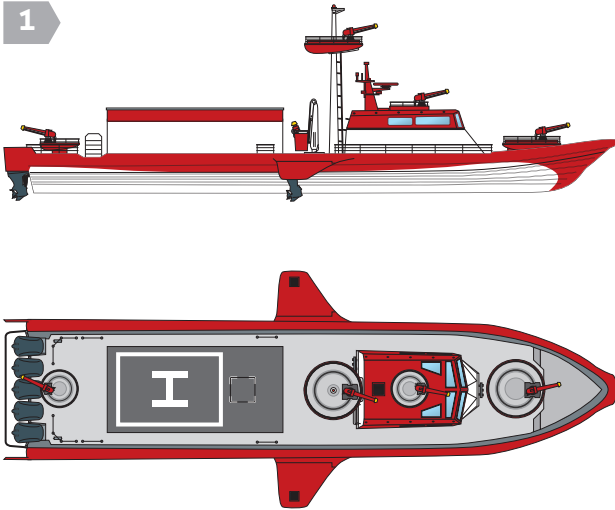

Technokontrol © Copyright. All Rights Reserved. All Designs & Applied Technologies Patented

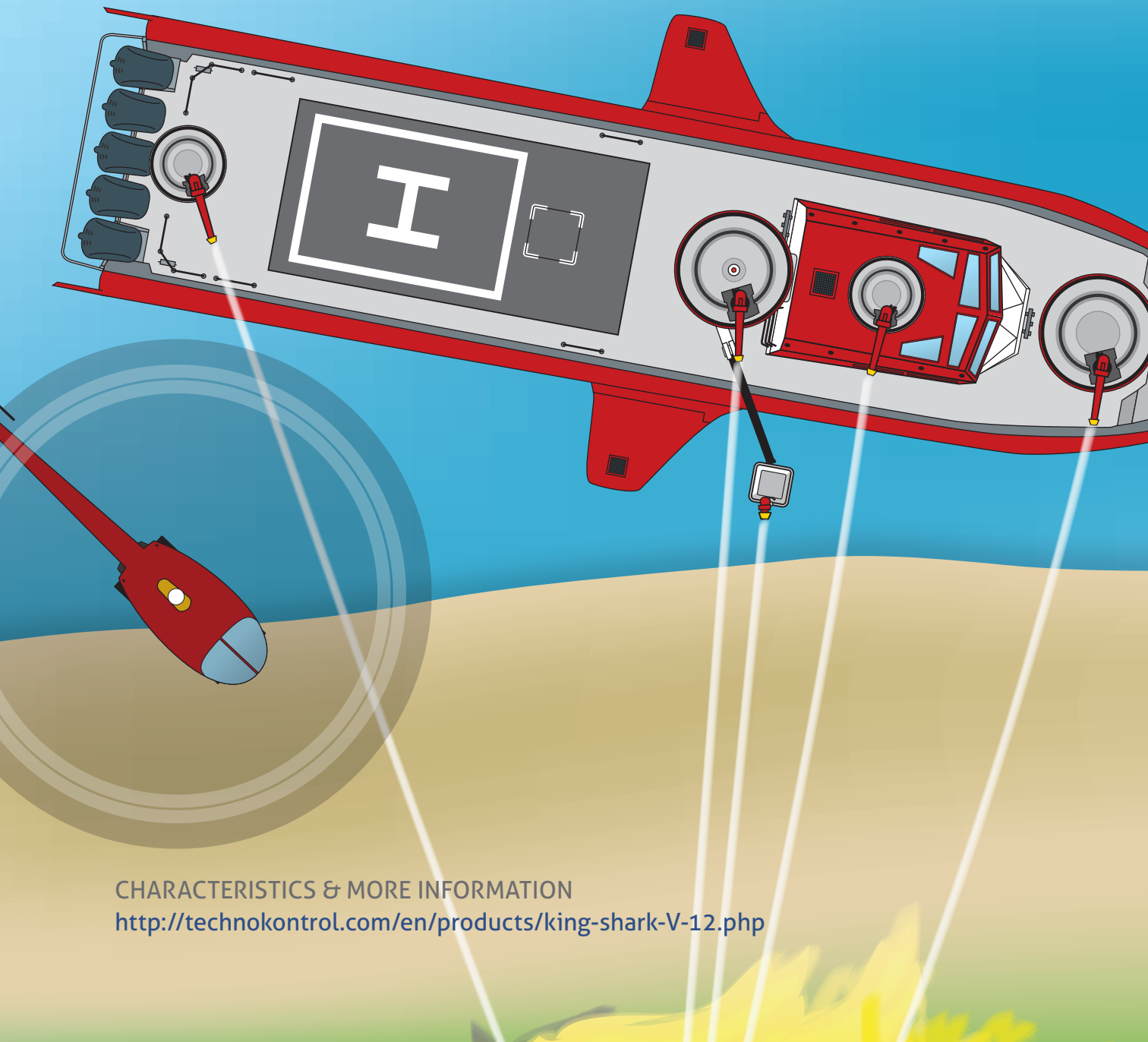

CHARACTERISTICS & MORE INFORMATION

<http://technokontrol.com/en/products/king-shark-V-12.php>

KING SHARK XIII FIRE SERVICES-LONG LADDER & UNMANNED LONG LADDER





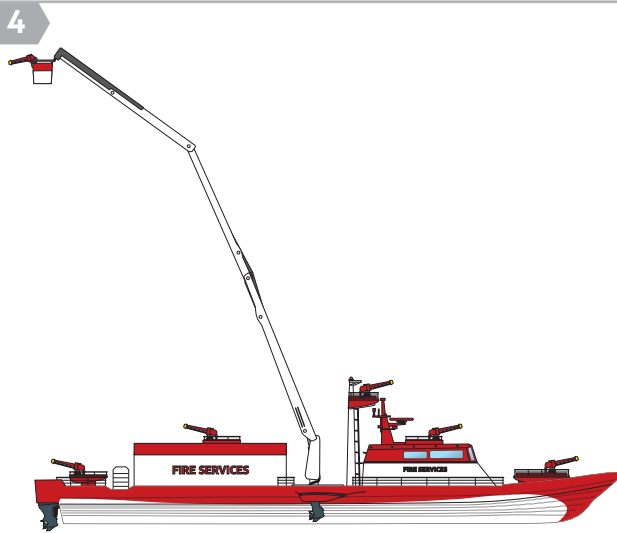
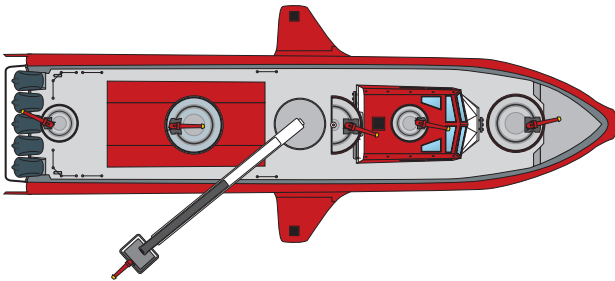
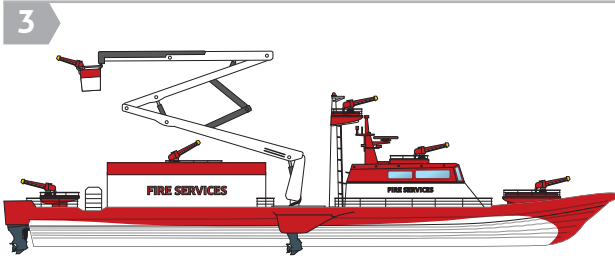
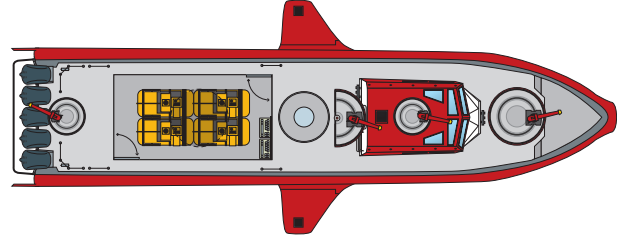
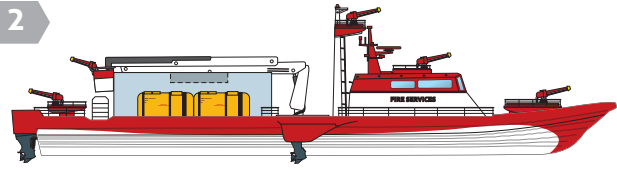
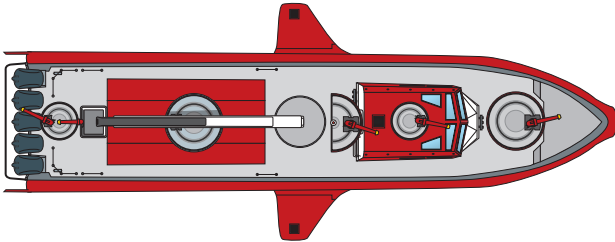
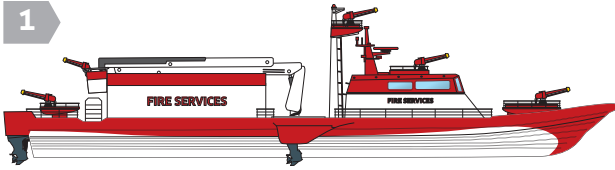

Technokontrol © Copyright. All Rights Reserved. All Designs & Applied Technologies Patented

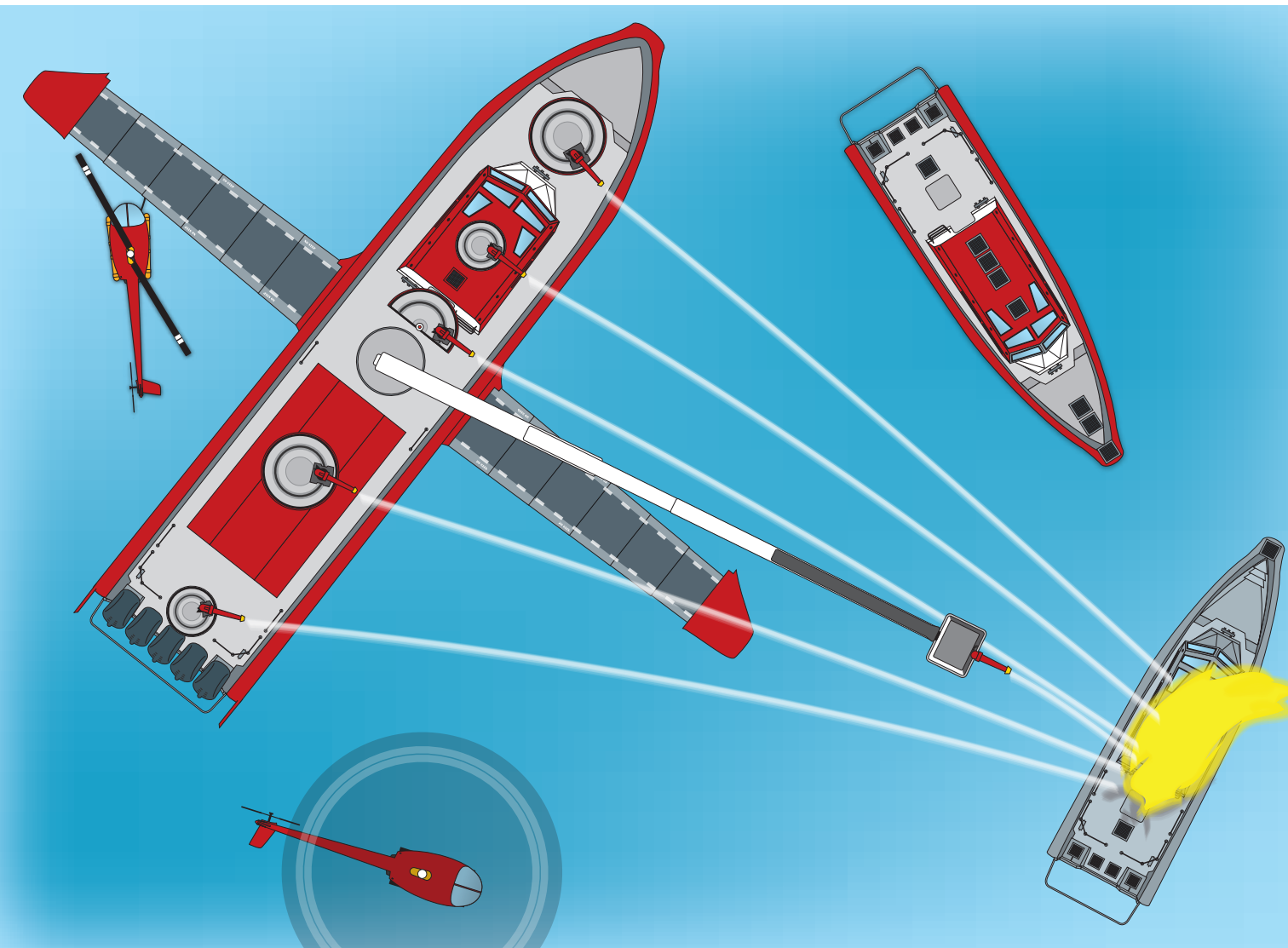

CHARACTERISTICS & MORE INFORMATION

<http://technokontrol.com/en/products/king-shark-V-13.php>

LONG LADDER



UNMANNED WATER CANNON



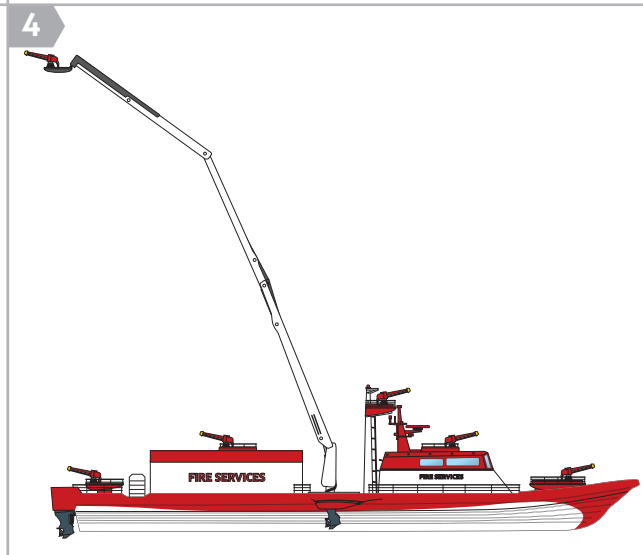
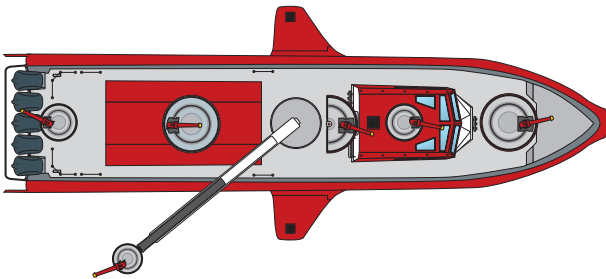
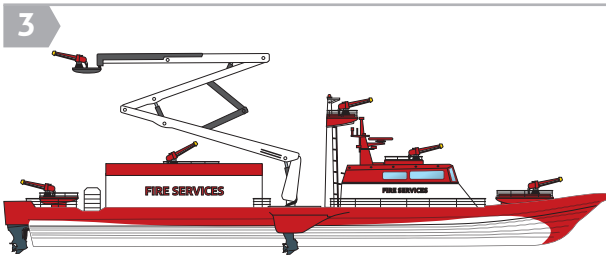
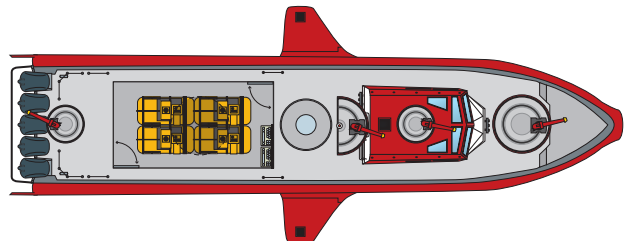
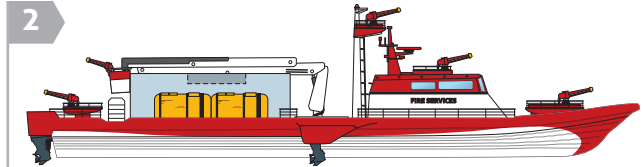
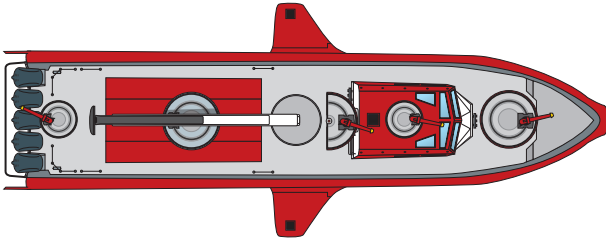
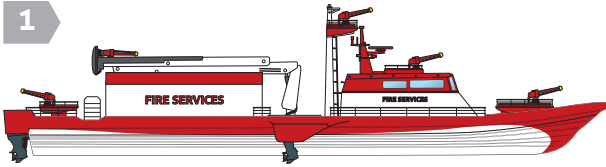

Technokontrol © Copyright. All Rights Reserved. All Designs & Applied Technologies Patented

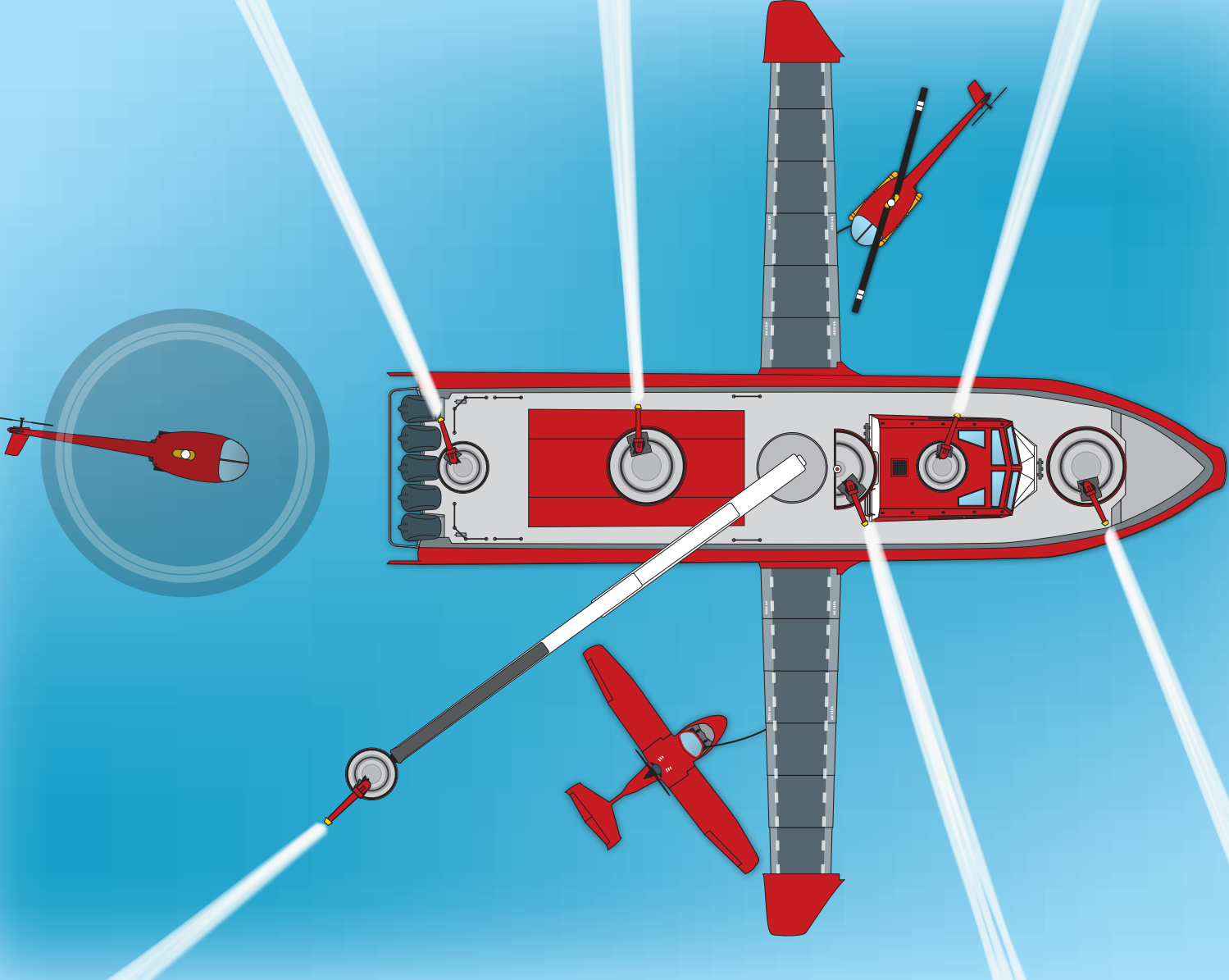

UNMANNED LONG LADDER

CHARACTERISTICS & MORE INFORMATION

<http://technokontrol.com/en/products/king-shark-V-13g.php>



KING SHARK XIV LONG RANGE RADAR

Operation control vessel with
extendible long range radar.



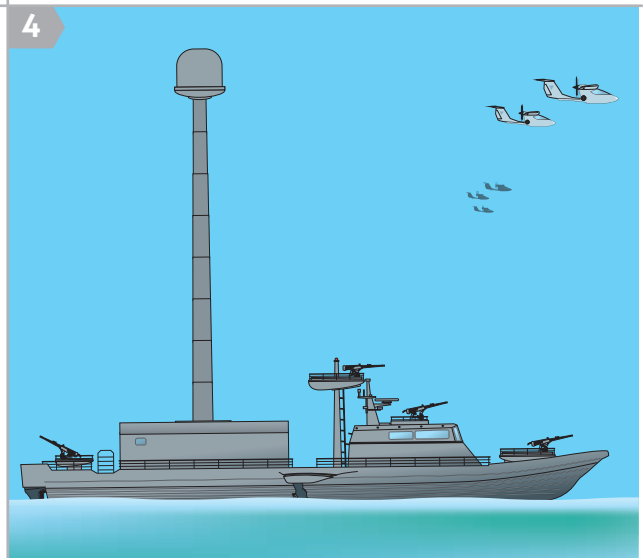
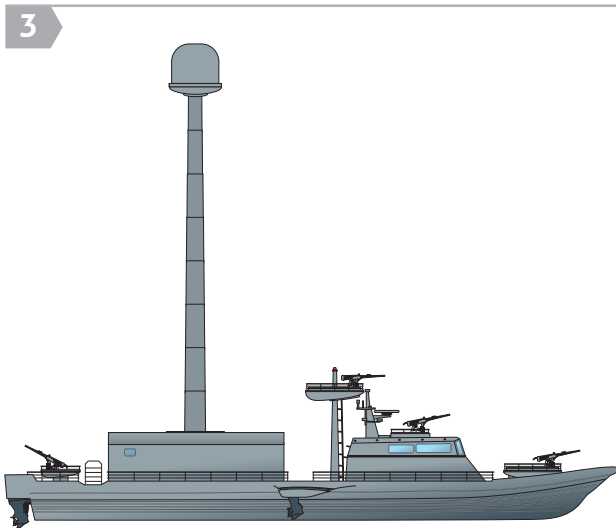
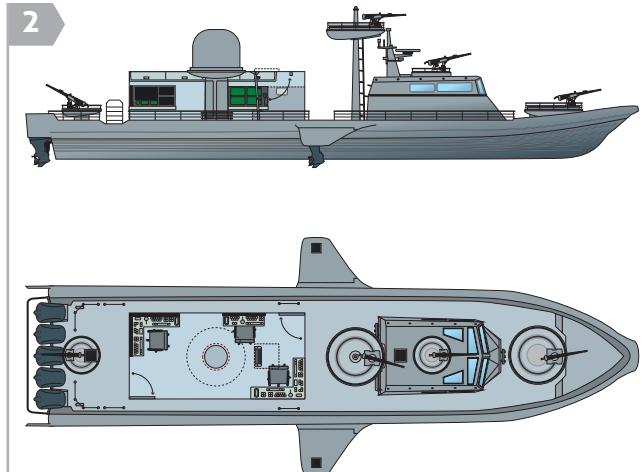
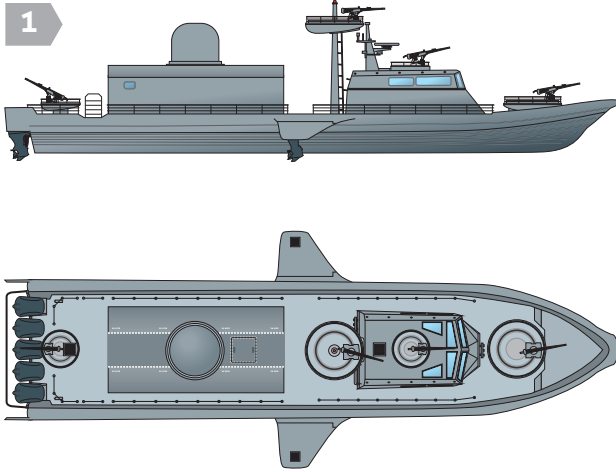

Technokontrol © Copyright. All Rights Reserved. All Designs & Applied Technologies Patented

CHARACTERISTICS & MORE INFORMATION

<http://technokontrol.com/en/products/king-shark-V-14.php>





KING KILLER WHALE HEAVY MULTI-USE CARRIER

The King Killer Whale can carry up to 6 Eagle Eye airplanes and has 2 integrated cranes to load/unload airplanes into position.



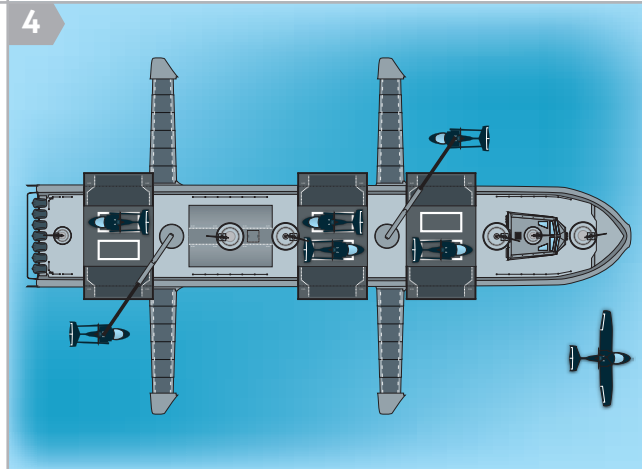
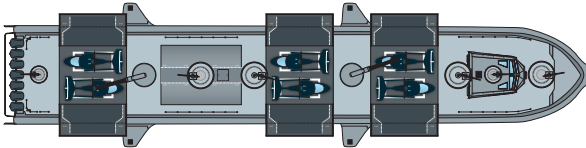
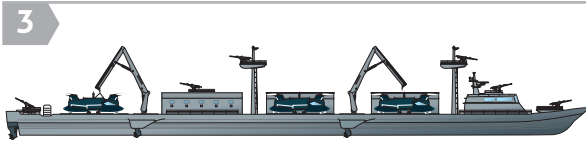
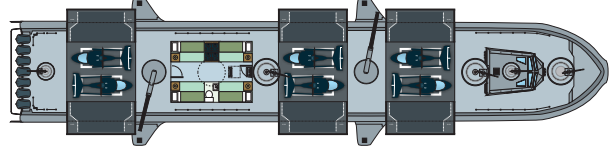
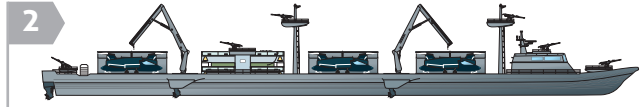
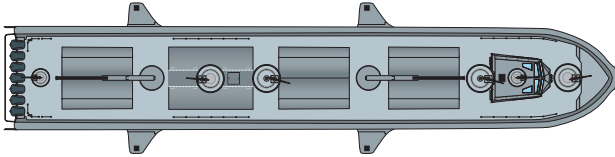
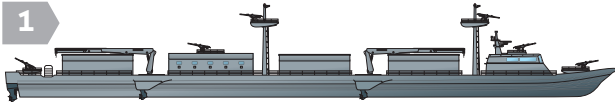

Technokontrol © Copyright. All Rights Reserved. All Designs & Applied Technologies Patented

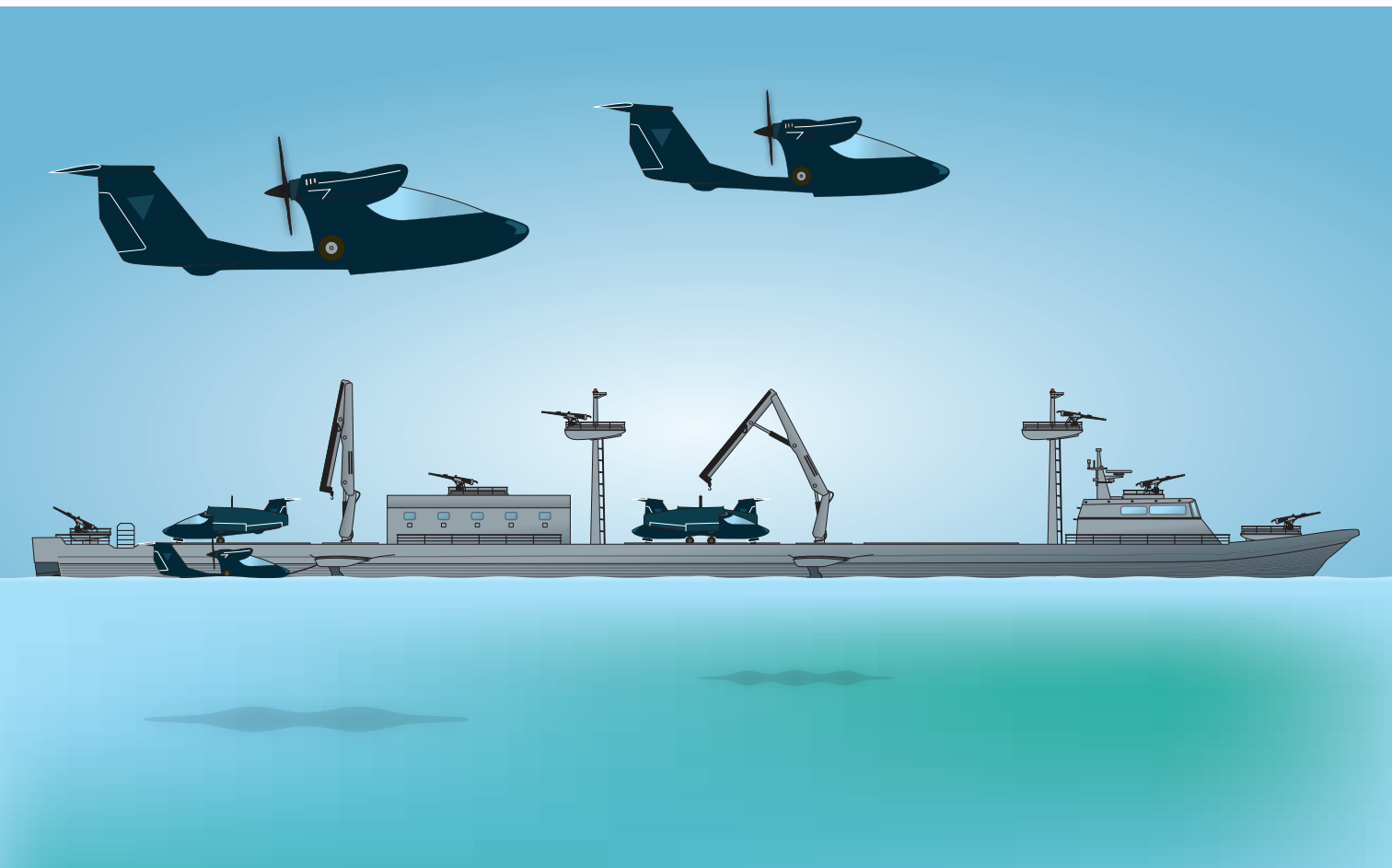

KING KILLER WHALE

CHARACTERISTICS & MORE INFORMATION

<http://technokontrol.com/en/products/killer-whale-V.php>



KING KILLER WHALE HEAVY HELICOPTER CARRIER



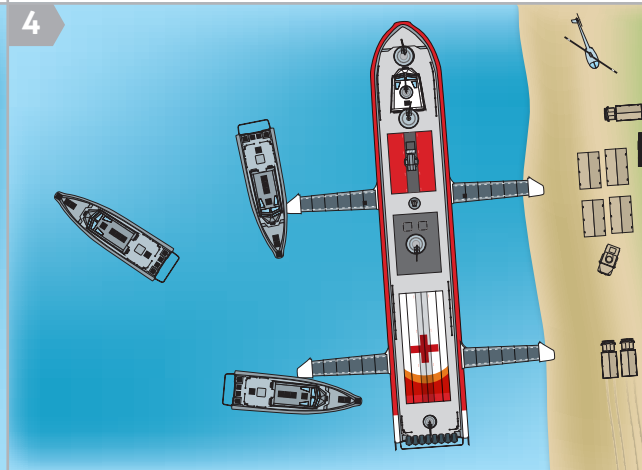
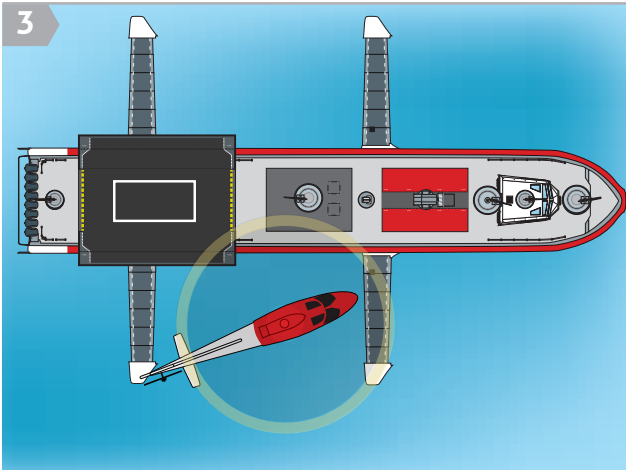
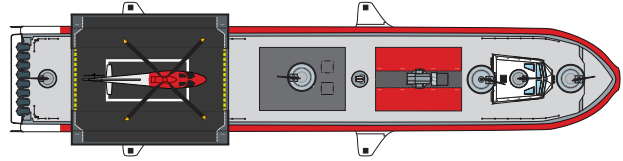
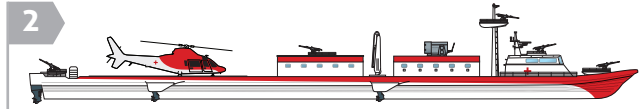
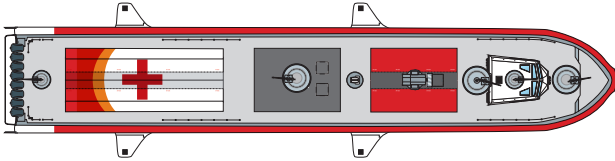
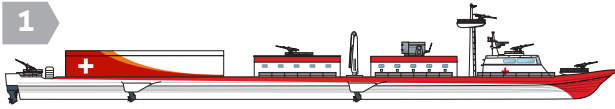

Technokontrol © Copyright. All Rights Reserved. All Designs & Applied Technologies Patented



BEWARE OF TAIL ROTOR



KING KILLER WHALE MEGA MULTI-USE VESSEL



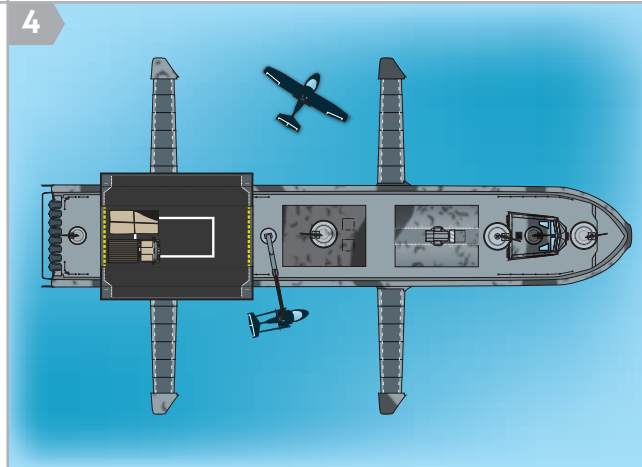
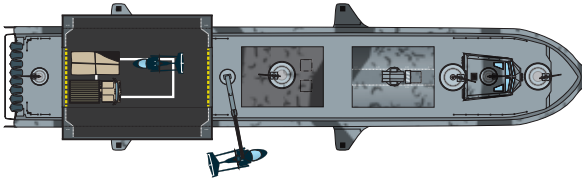
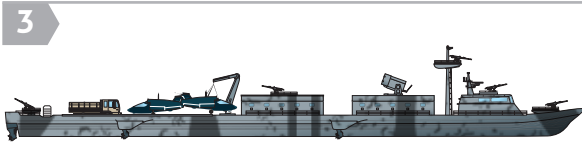
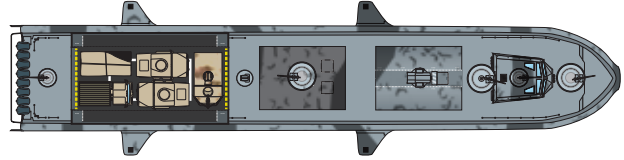
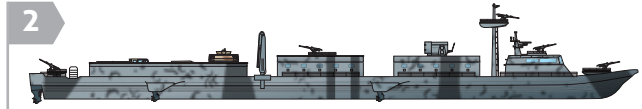
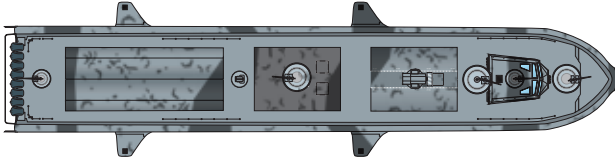
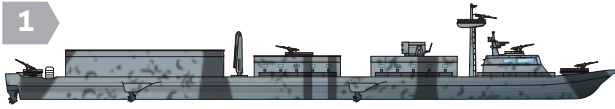

Technokontrol © Copyright. All Rights Reserved. All Designs & Applied Technologies Patented

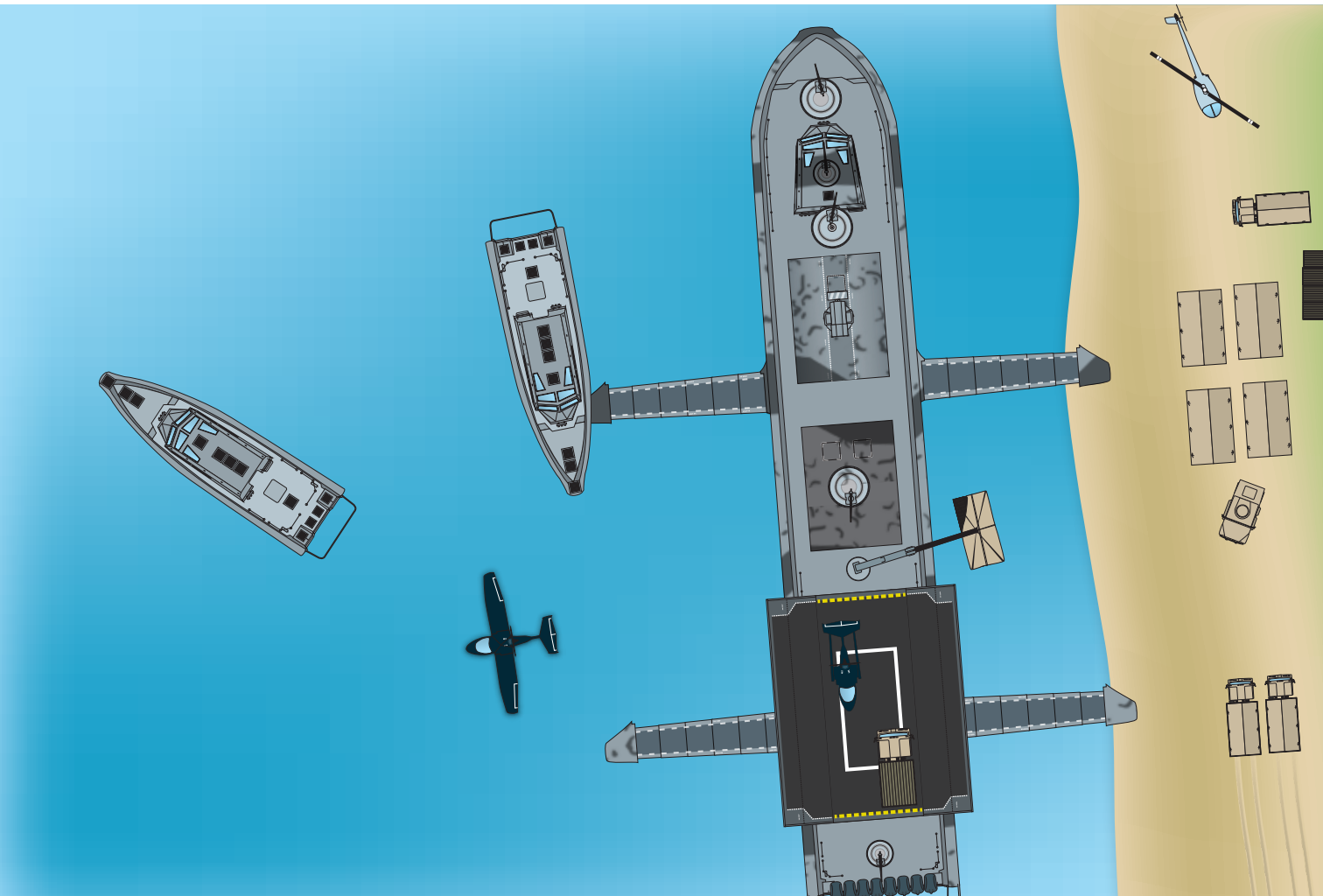

KING KILLER WHALE - MEGA MULTI-USE VESSEL

CHARACTERISTICS & MORE INFORMATION

[Click here to visit King Killer Whale web and watch a deployment animation](#)

KING KILLER WHALE LONG RANGE RADAR



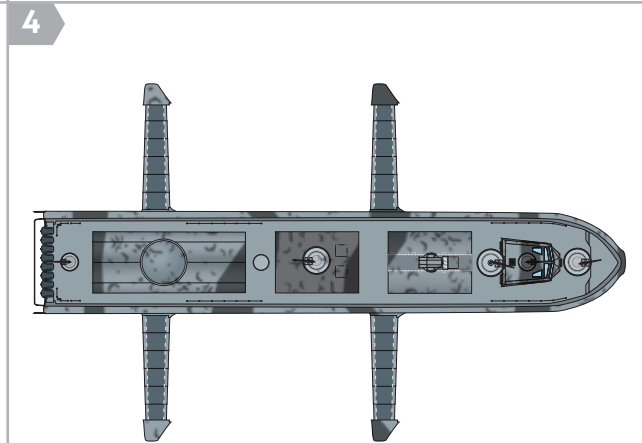
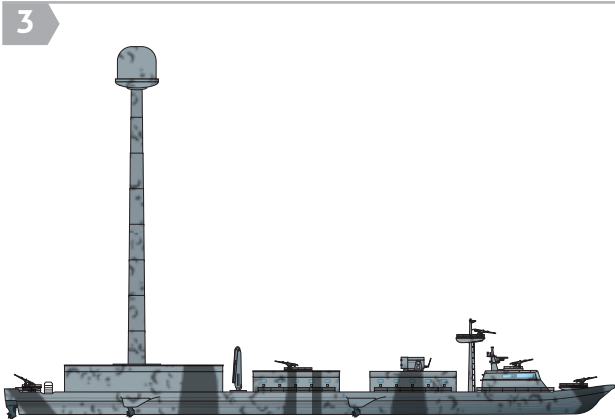
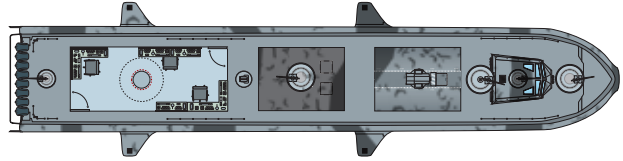
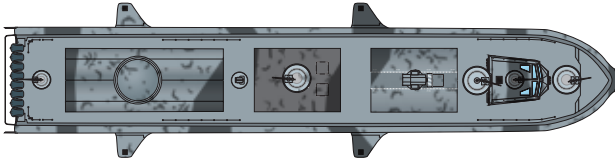
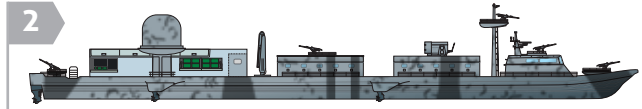
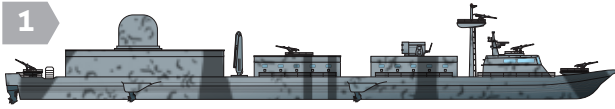

Technokontrol © Copyright. All Rights Reserved. All Designs & Applied Technologies Patented

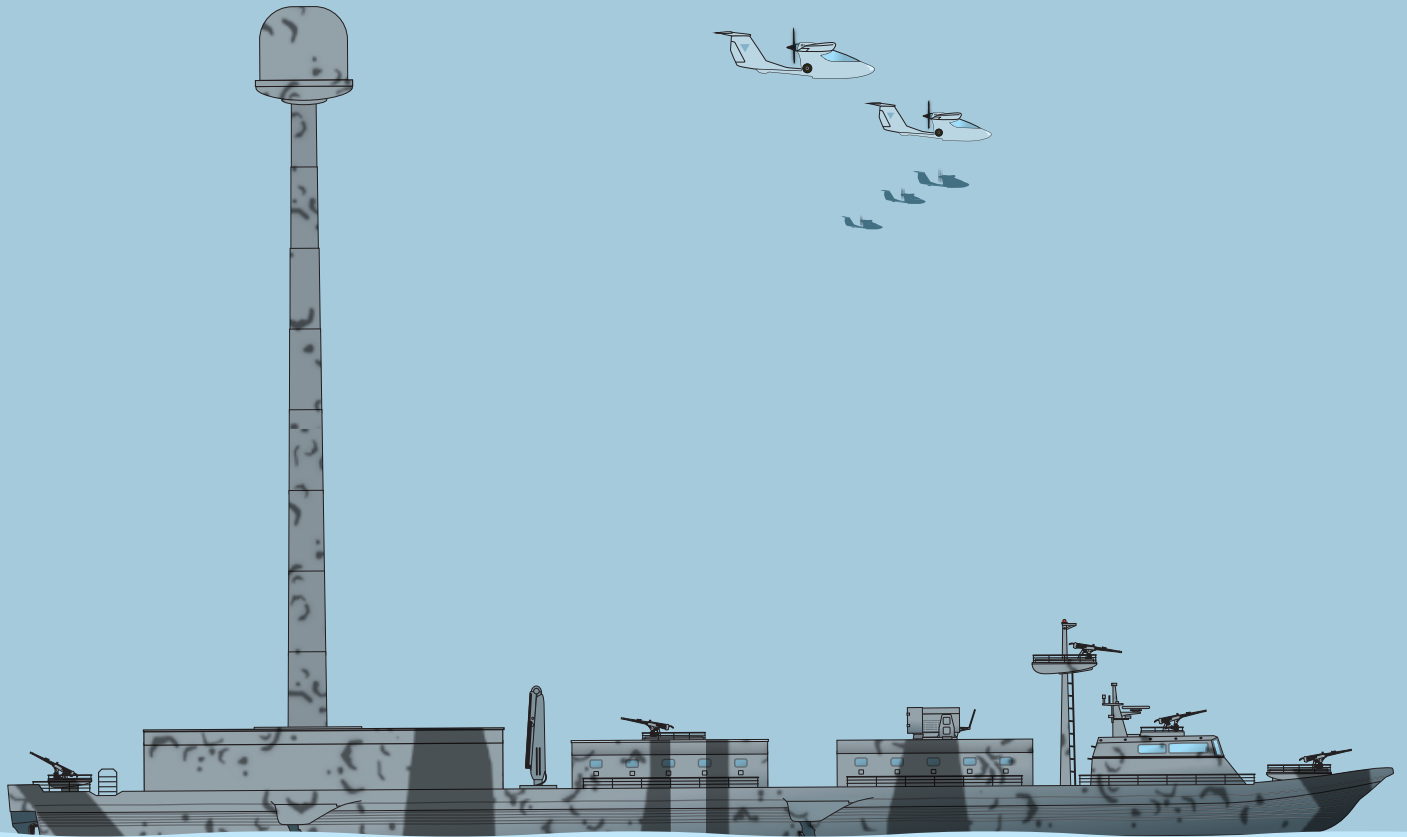

KING KILLER WHALE - LONG RANGE RADAR

CHARACTERISTICS & MORE INFORMATION

[Click here to visit King Killer Whale web and watch a deployment animation](#)



KING KILLER WHALE HIGH SPEED PATROL VESSEL CARRIER

ELITE GHOST DIVISION SPECIAL TASK FORCE VESSELS



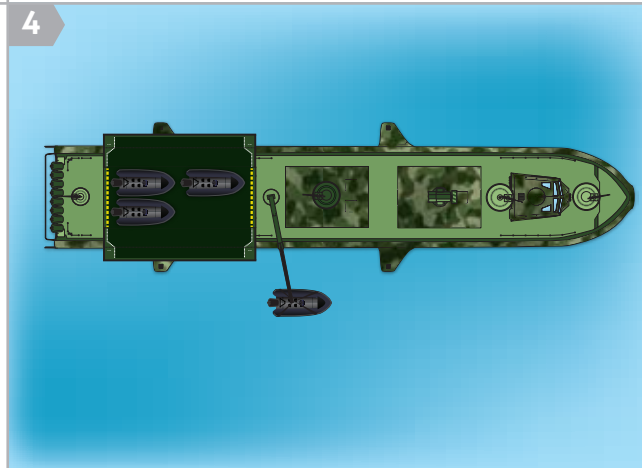
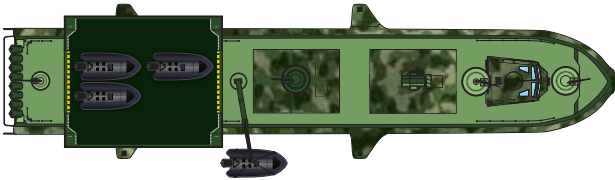
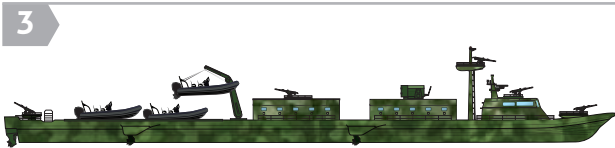
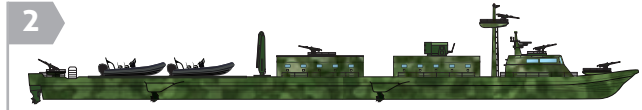

Technokontrol © Copyright. All Rights Reserved. All Designs & Applied Technologies Patented

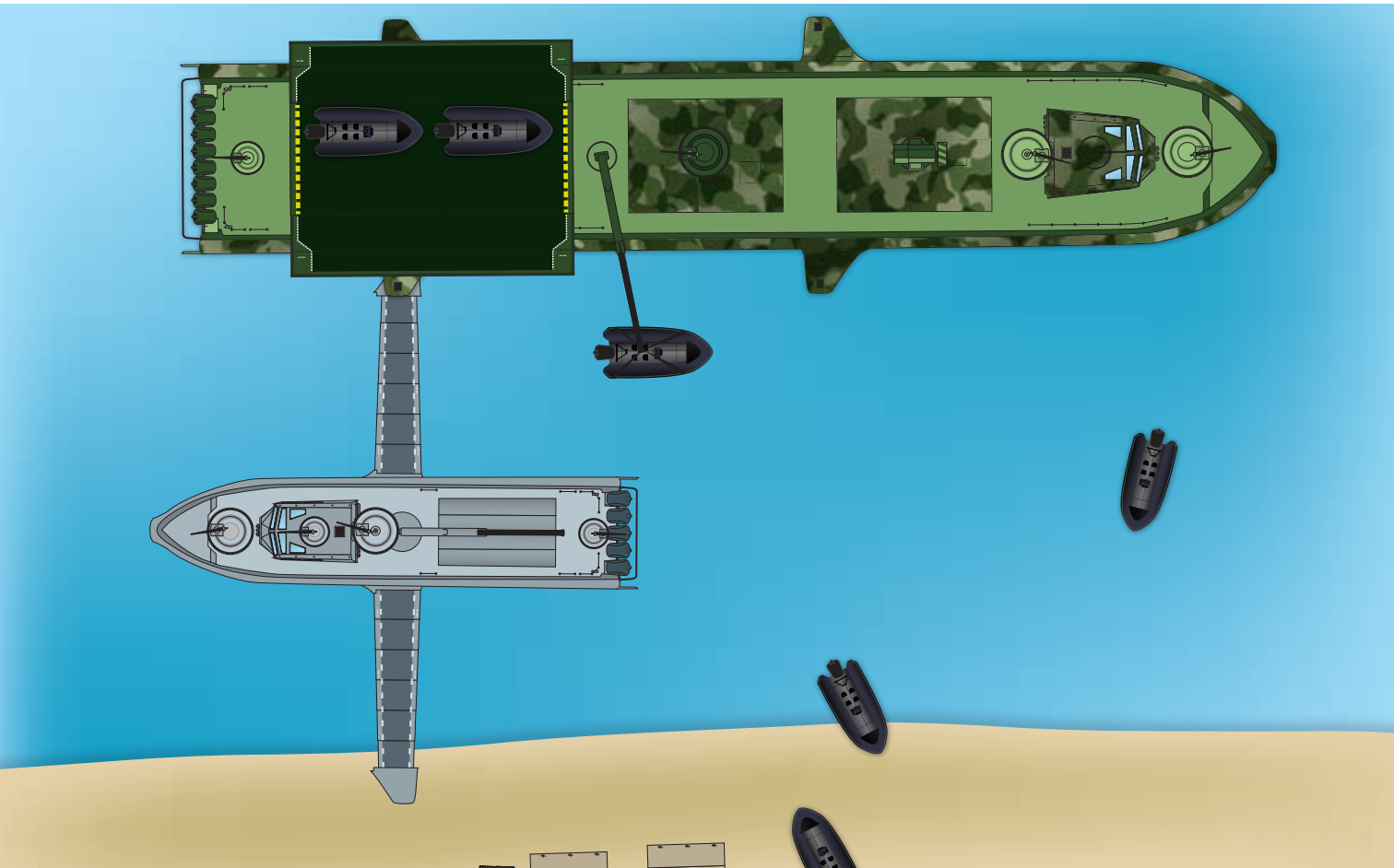

KING KILLER WHALE - HIGH SPEED PATROL VESSEL CARRIER

CHARACTERISTICS & MORE INFORMATION

[Click here to visit King Killer Whale web and watch a deployment animation](#)



Elite
Ghost Division



KING KILLER WHALE HEAVY FUEL CARRIER



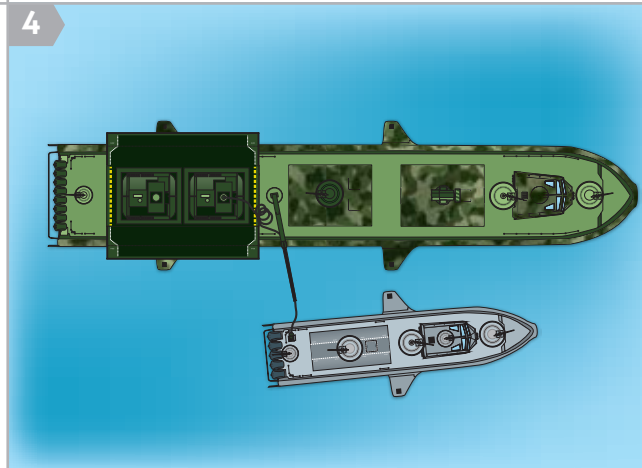
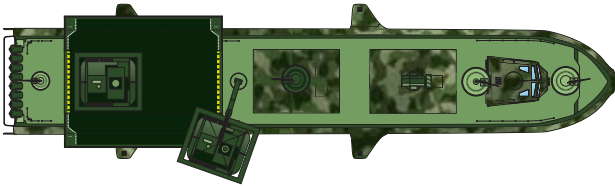
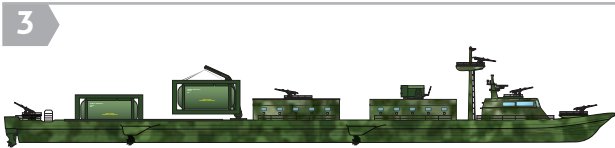
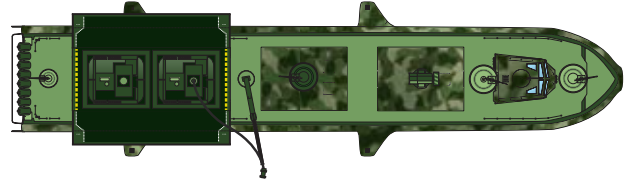

Technokontrol © Copyright. All Rights Reserved. All Designs & Applied Technologies Patented

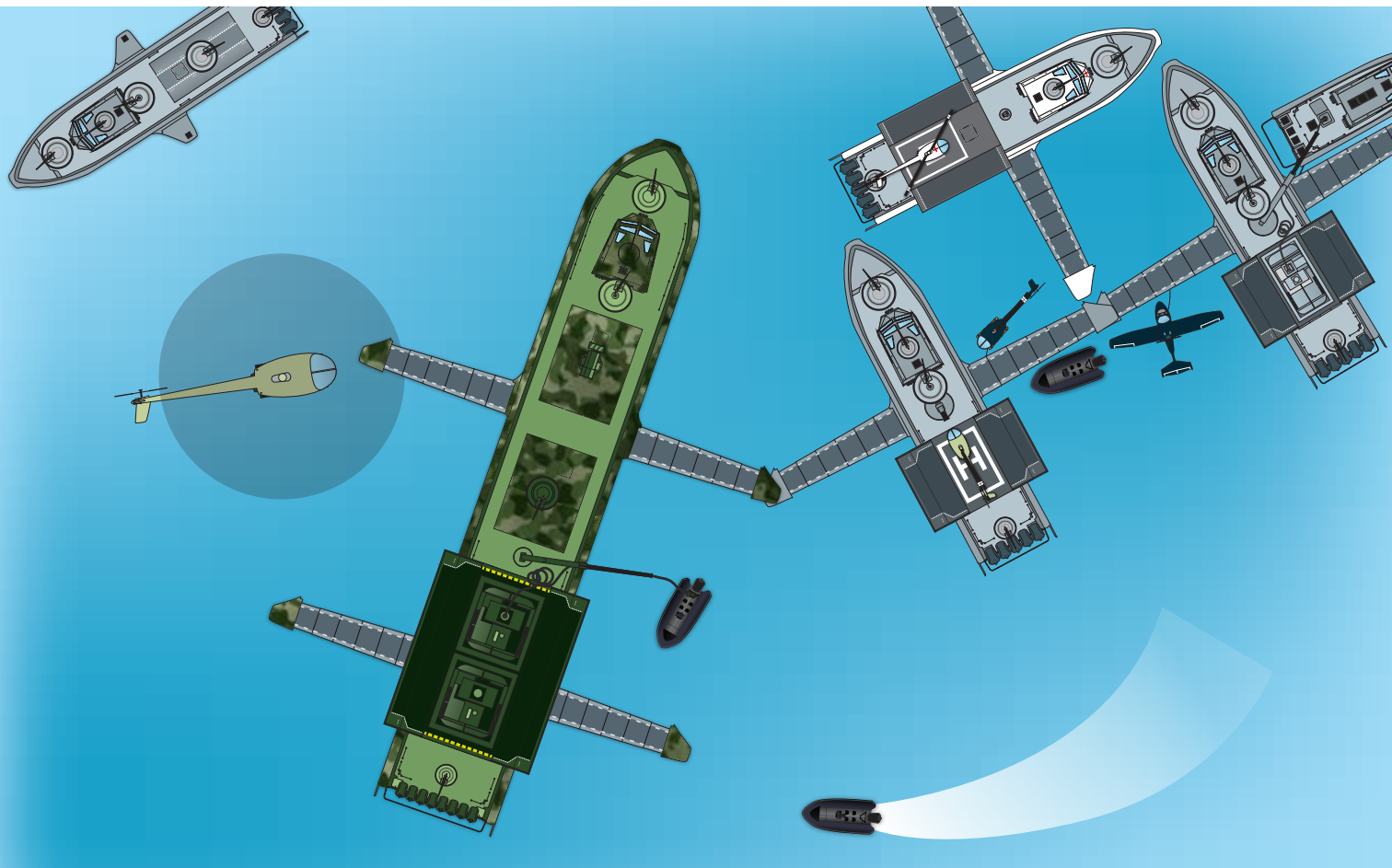

KING KILLER WHALE -HEAVY FUEL CARRIER

CHARACTERISTICS & MORE INFORMATION

[Click here to visit King Killer Whale web and watch a deployment animation](#)



KING KILLER WHALE PLASMA FUSION GUNSHIP



1



2



3



4

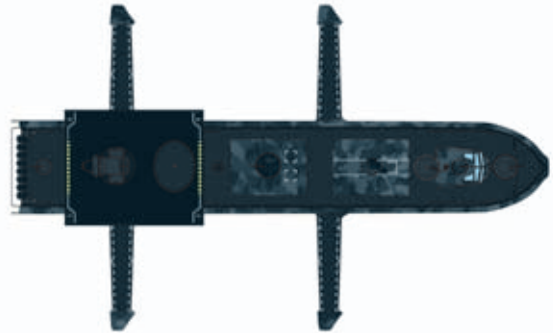

Technokontrol © Copyright. All Rights Reserved. All Designs & Applied Technologies Patented



KING KILLER WHALE - PLASMA FUSION GUNSHIP

CHARACTERISTICS & MORE INFORMATION

 [Click here to visit King Killer Whale web and watch a deployment animation](#)



KING KILLER WHALE AERIAL-MARITIME-TERRESTRIAL REFUELING VESSELS

BAD WEATHER, NIGHT, EMERGENCY, COMBAT "T-PLATTFORM" VESSEL
REFUELING/MUNITIONS LANDING "TOUCH & GO" SAFETY PLATAFORMS



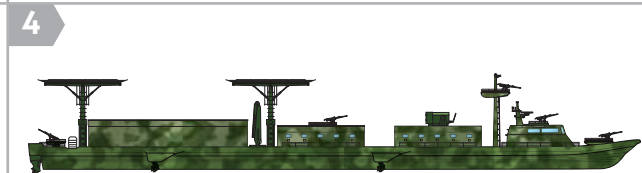
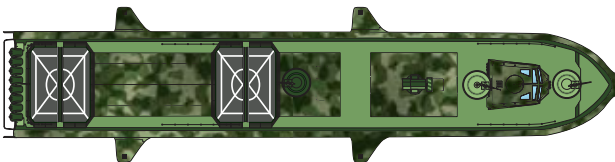
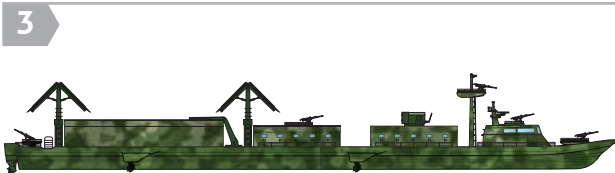
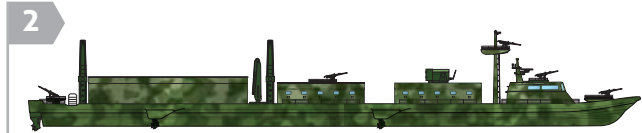
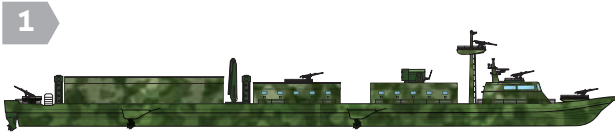

Technokontrol © Copyright. All Rights Reserved. All Designs & Applied Technologies Patented

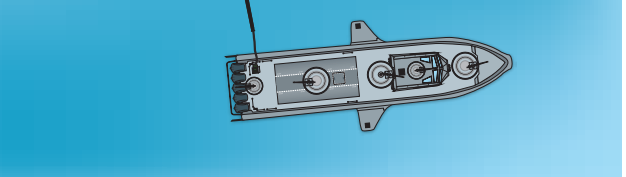
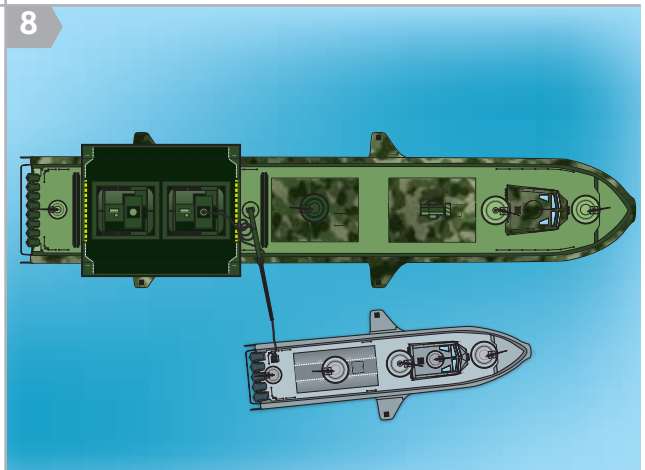
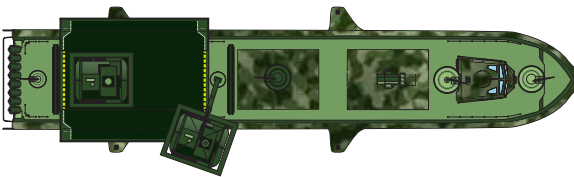
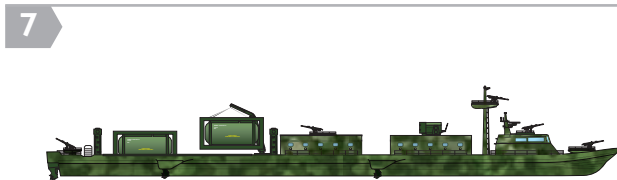
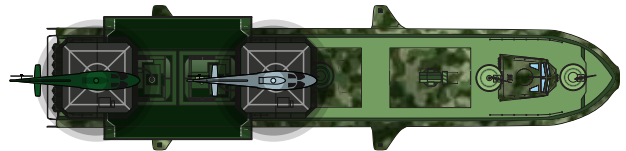
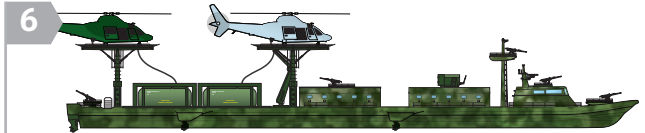
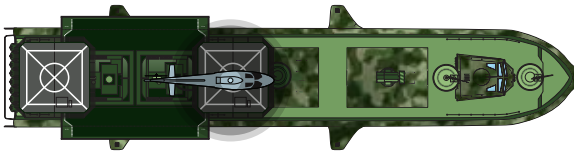

KKW - AERIAL-MARITIME-TERRESTRIAL REFUELING VESSELS

CHARACTERISTICS & MORE INFORMATION

 [Click here to visit King Killer Whale web and watch a deployment animation](#)

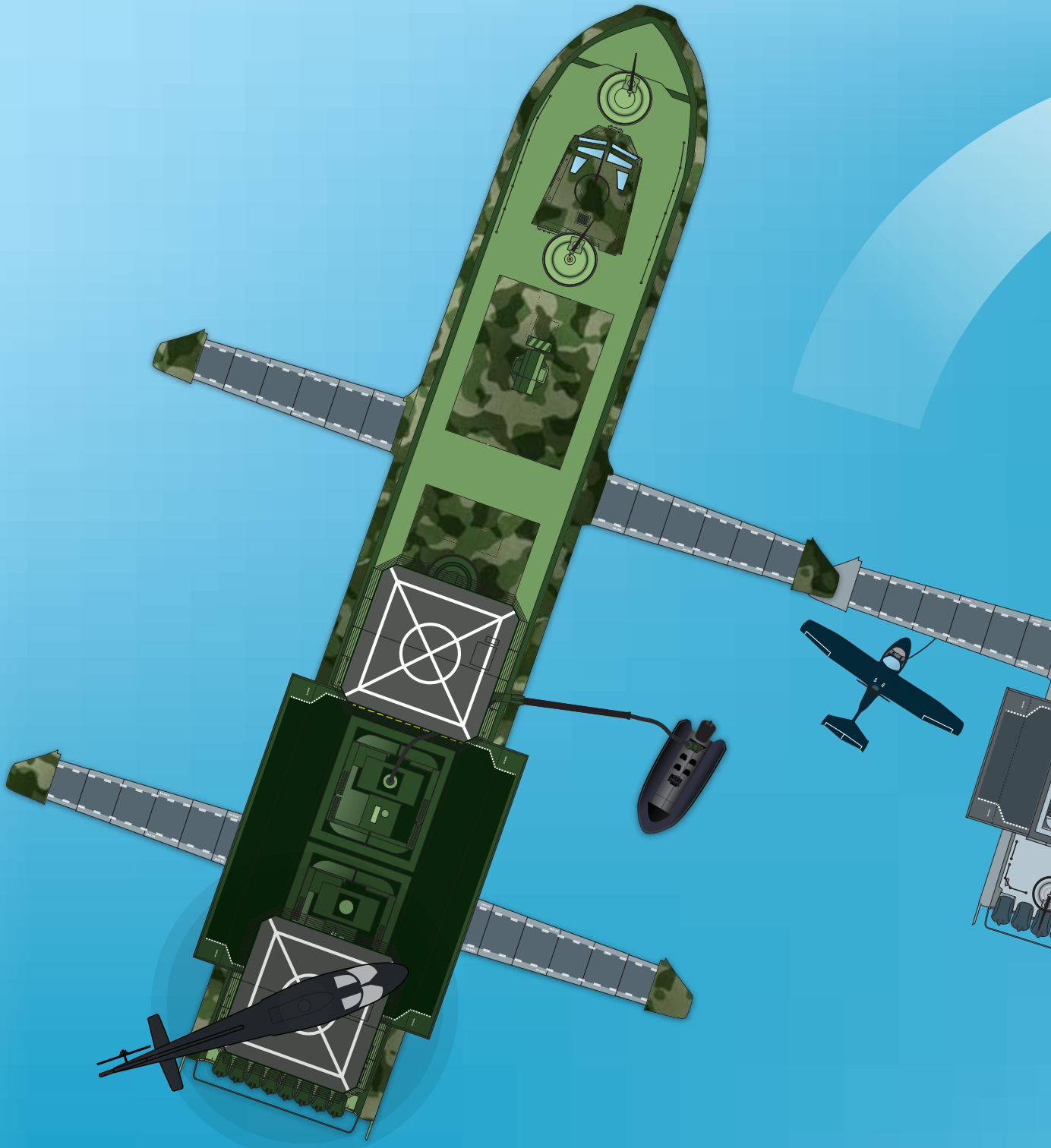

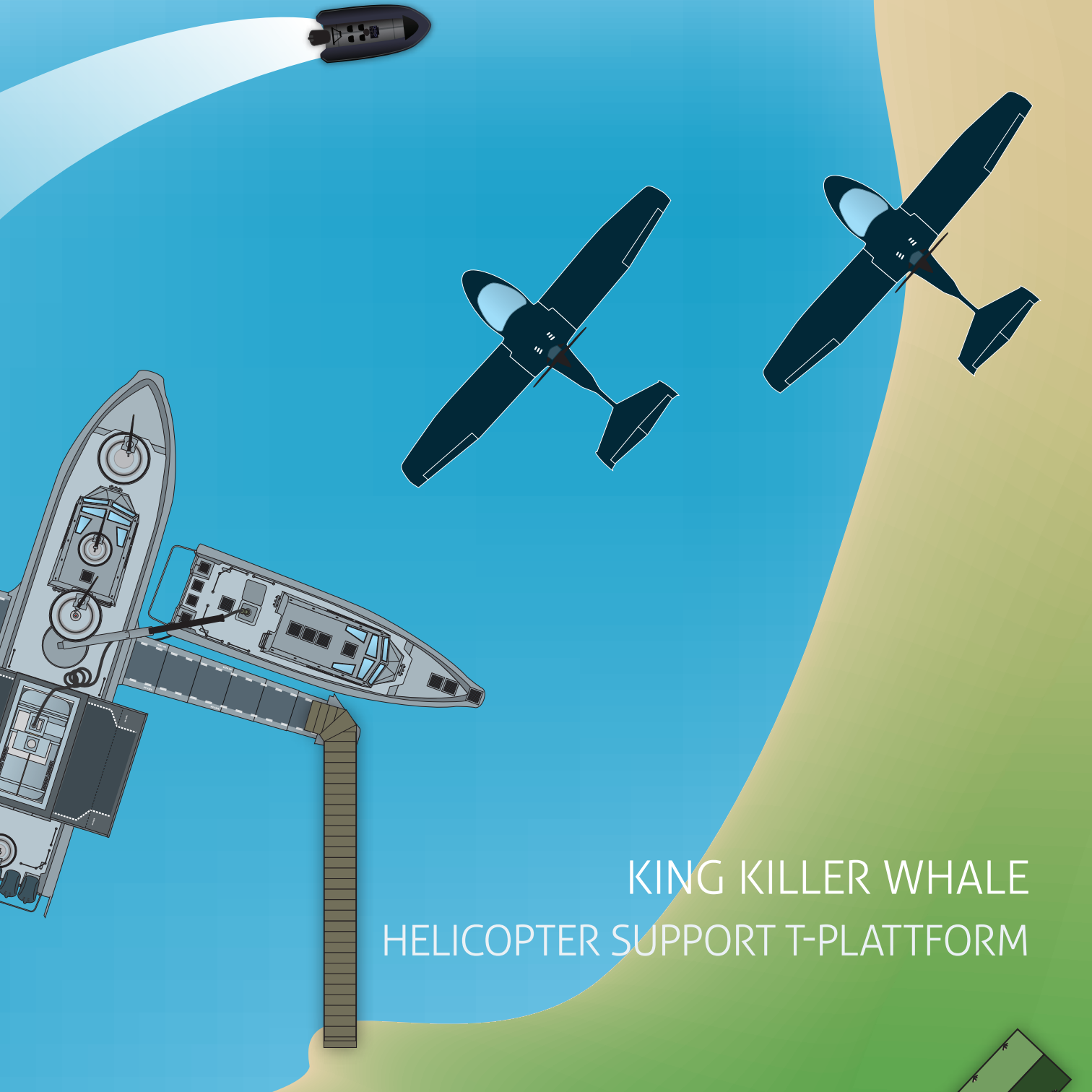

KING KILLER WHALE
HELICOPTER SUPPORT T-PLATFORM



BULLET PROOF LEVEL III-VIII+ ANTI-EMP
CABIN (HUMAN & ASSET PROTECTION
PARAMOUNT)

TWO TO EIGHT MACHINE GUNS THAT CAN
BE OPERATED BY NAVY PERSONNEL OR VIA
A JOYSTICK AND VIDEO CAMERA



ANTI-EXPLOSION, ANTI-OXIDATION, ANTI-SLOSH, ANTI-ALGAE GROWTH, FUEL TANKS FILTERING TO INCREASE SPEED

SPECIAL BULLET LEVEL III-VIII+ PROOF ENGINE COVERING (PROTECTION COVERING TO REDUCE BULLET SHOTS)

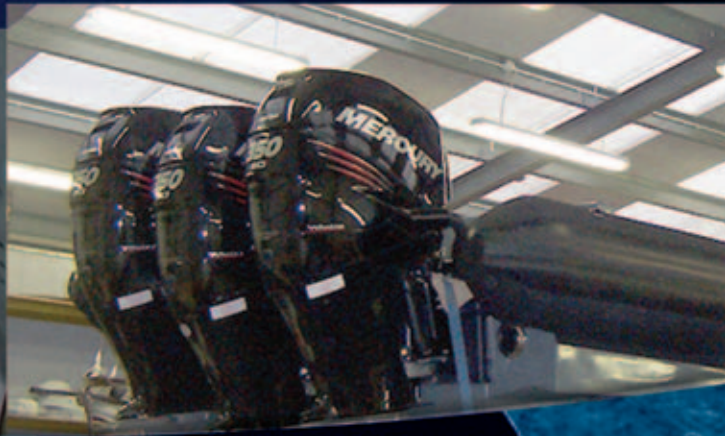

VESSEL TRAFFIC SERVICES (VTS) & AUTOMATIC IDENTIFICATION SYSTEMS (AIS)-(RAIS)

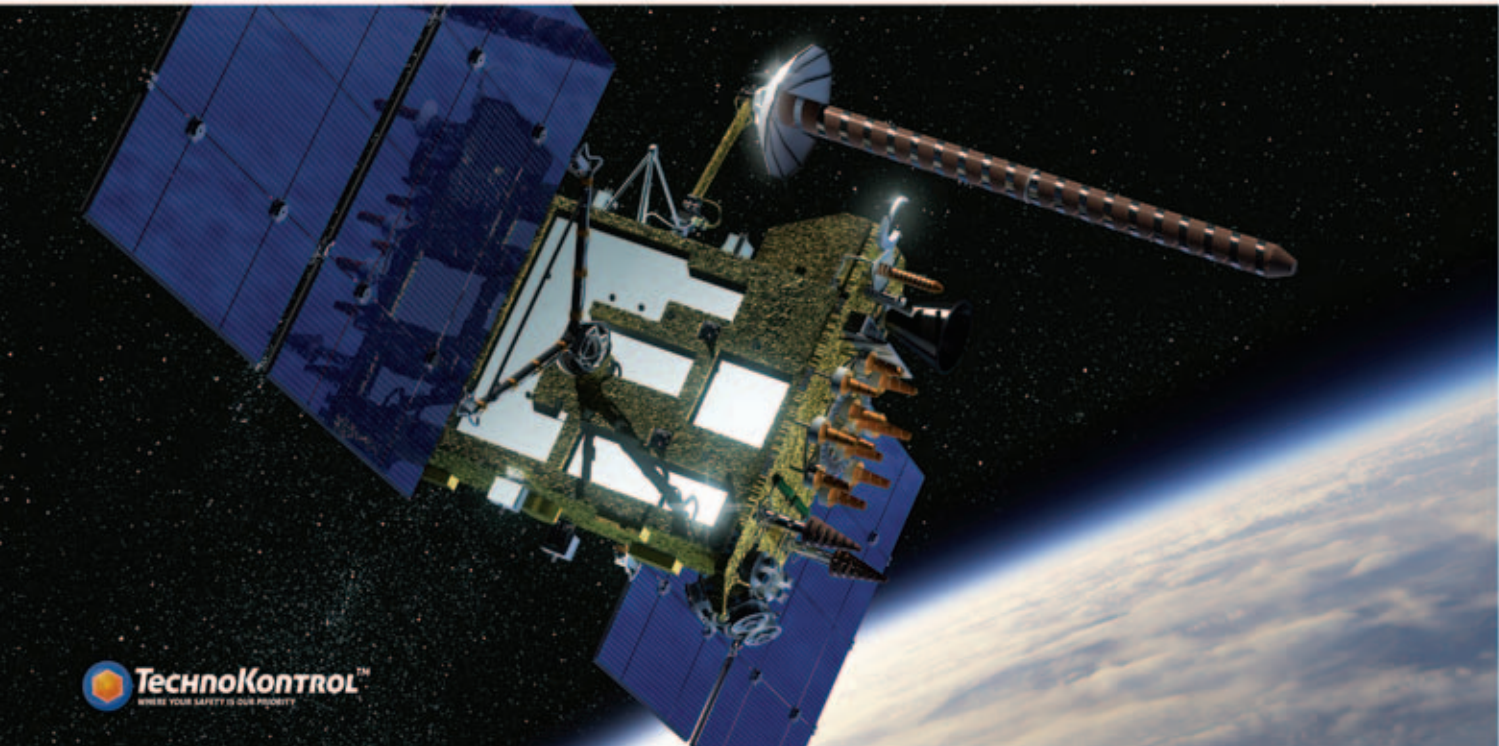

Vessel Traffic Service (VTS) is designed to improve vessel traffic safety and efficiency. It also offers the potential to respond appropriately to traffic situations emerging in an area, including toll services, traffic control, security, safety, etc.



CHARACTERISTICS & MORE INFORMATION

<http://technokontrol.com/en/products/ais-vts.php>

MARITIME & SUBMARINE TECHNOLOGIES BLACK NIGHT VIPER MARITIME



CHARACTERISTICS & MORE INFORMATION

<http://technokontrol.com/en/products/submarine.php>

SAFE HAVEN MILITARY MOBILE OPERATIONAL PLATFORM

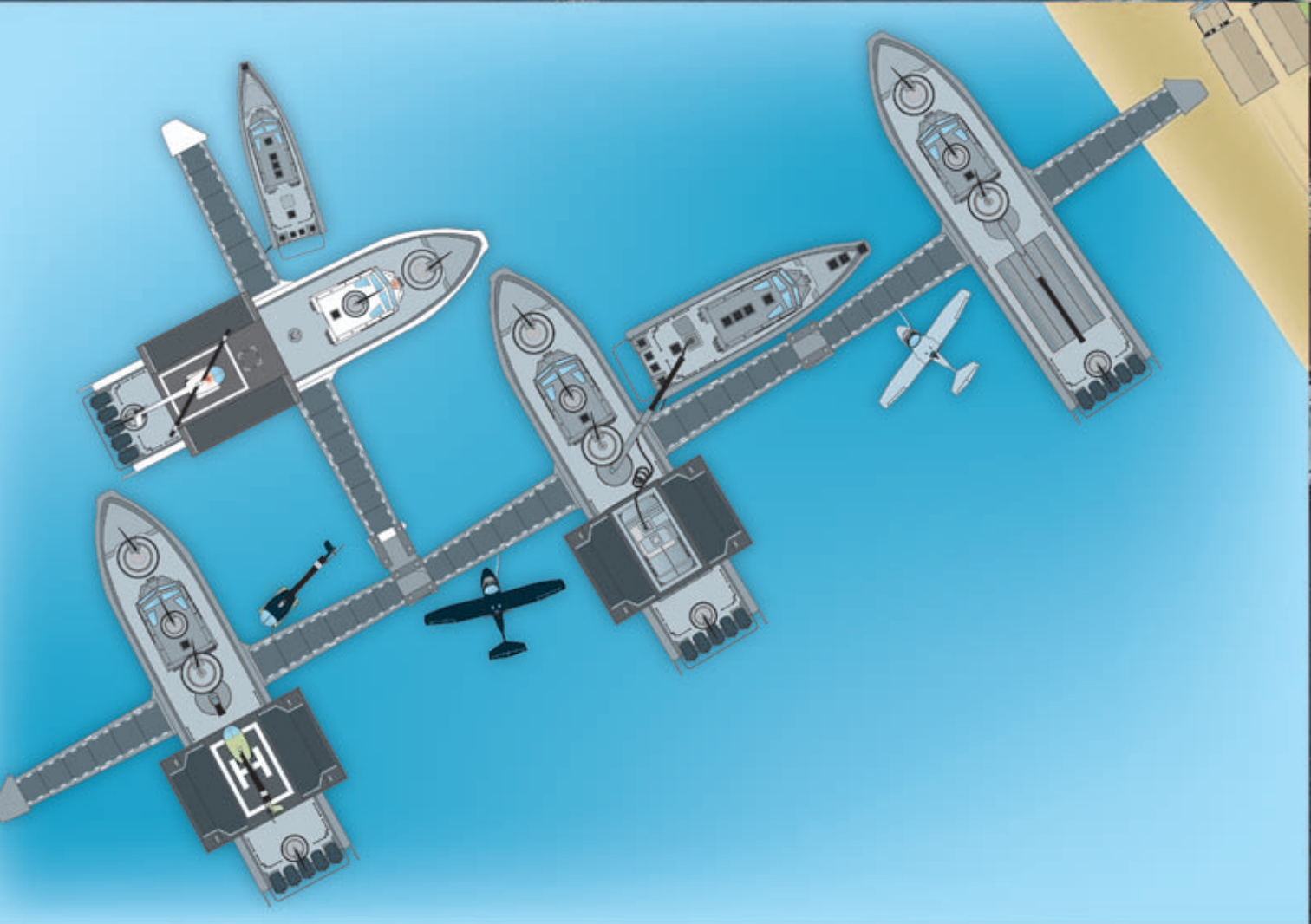



BLACK NIGHT VIPER MILITARY TECHNOLOGIES & TECHNOKONTROL have studied extremely carefully the new concepts of modern day ,naval, river, land, aerial warfare, law enforcement including logistics, exploration, supply, refueling, rescue-safety, medical, humanitarian, multi-use rolls, in which due to the continuous financial government “cut backs” every cent invested in any technology or future technology in these fields of operations are extremely important thus having to design, manufacture, install, maintain, financially amortize by means of longer operational life these military, law enforcement, logistical, multi-use technologies, products and services.

MORE INFORMATION

<http://technokontrol.com/en/products/bases.php>



OIL TANKERS, BARGES, PORTS & VESSELS SAFETY, SECURITY & EFFICIENCY



TK-Maritime offer its clients the possibility to use several of its unique, patented, guaranteed safety, security, efficiency technologies for the use of any petro-chemical transports, especially by maritime transportation methods. TechnoKontrol can offer many benefits which are being used already by government navy and safety maritime departments around the World.

MORE INFORMATION

<http://technokontrol.com/en/products/tankers.php>

HELIPADS / HELIPORTS

Helipads & Heliports is a sector of TechnoKontrol Technologies specialized in safety, security, efficiency, environmental technologies in all petroleum, technology based sectors and also in the design, construction, installation of surface heliports, rooftop helipads, offshore helidecks, and private airports.

Technokontrol Helipads provides complete key in hand-full operations consultancy, engineering, and equipment services in compliance with CAA and FAA/EASA Airport and Heliport guidelines.

We offer an extensive track record and expertise in developing the finest landing platforms.

MORE INFORMATION

 <http://technokontrol.com/en/products/helipads.php>



CERTIFICATES



**Architects
Engineers
Building
Officials
Section**

JAA



CE



National Fire Protection Association
The authority on fire, electrical and building safety

LEGAL NOTICE

Copyrights TechnoKontrol Cat Global S.L. All Rights Reserved. The text, images, graphics, sound files, animation files, video files and their arrangement on TechnoKontrol Cat Global S.L. Internet sites are all subject to Copyright and other intellectual property protection. These objects may not be copied for commercial use or distribution, nor may these objects be modified or reposted to other sites. Some Technokontrol Internet sites also contain material that is subject to the copyright rights of their providers. All modifications of the web or publicity can be done as the corporation requires. All web and publicity information is not contractual but only information.

Product variations. Some of the product information, illustrations and images contained on this Internet site or all types of publicity may have been prepared for generic use on Technokontrol Internet sites maintained in different countries around the world. Consequently, some of the information and/or accessories which are not available in some countries or which, in order to satisfy local market demand or regulatory controls in such countries, may only be available in different specifications or configurations.

If you are interested in any product, alloy, services, options or accessory shown on the Internet site or publicity and are unsure of its availability or specification in your locality, you should contact TechnoKontrol Cat Global S.L. and/or a local authorized dealer for the relevant product, for information of current details in your locality.

DISCLAIMER

We do not make representation that information and materials on this website and corporate publicity are appropriate for use in all jurisdictions available on the web, or that transactions, securities, products, instruments or services offered on this website or publicity are available or indeed appropriate for sale or use in all jurisdictions, or by all investors or other potential clients. Those who access this website or publicity do so on their own initiative, and are therefore responsible for compliance with applicable local laws and regulations. By accessing each site, the entrant has agreed that he/she has reviewed the website or publicity in its entirety including any legal or regulatory terms.

AVISO LEGAL

PROPIEDAD INDUSTRIAL E INTELECTUAL

Estos textos e imágenes, así como todo tipo de publicidad en cualquier formato es propiedad de TechnoKontrol Cat Global SL. Los derechos de Propiedad Intelectual y derechos de explotación y reproducción de esta Web y publicidad, de sus páginas, pantallas, la información que contienen, su apariencia y diseño, así como los vínculos ("hiperlinks") que se establezcan desde ella a otras páginas web de cualquier sociedad perteneciente al Grupo, son propiedad exclusiva de éste salvo que se especifique otra cosa. Todas las denominaciones, diseños y/o logotipos que componen esta página son marcas debidamente registradas. Cualquier uso indebido de las mismas por persona diferente de su legítimo titular podrá ser perseguido de conformidad con la legislación vigente. Los derechos de propiedad intelectual y marcas de terceros están destacados convenientemente y deben ser respetados por todo aquel que acceda a la Web y los folletos informativos. Solo para uso personal y privado se permite descargar los contenidos, copiar o imprimir cualquier página de esta Web. Queda prohibido reproducir, transmitir, modificar o suprimir la información, contenido o advertencias de esta Web sin la previa autorización escrita de TechnoKontrol Cat Global S.L. Toda la información expuesta en la página web o en cualquier tipo de formato publicitario es únicamente informativo y no constituye ninguna obligación contractual.

DROITS D'AUTEUR

Copyright TechnoKontrol Cat Global S.L.. Tous droits réservés. Tous les textes, images, graphiques, sons, vidéo et animations ainsi que leur arrangement ou disposition sont protégés au titre du droit d'auteur et aux autres lois relatives à la protection de la propriété intellectuelle. Ils ne peuvent être ni modifiés, ni copiés à des fins commerciales ou à des fins de reproduction, ni utilisés sur d'autres sites web.

Marques commerciales. En l'absence d'indication contraire, toutes les marques mentionnées sur les pages internet de TechnoKontrol sont des marques déposées par TechnoKontrol Cat Global S.L. et protégées sur un plan légal. Cela concerne en particulier les noms de produits ou services ainsi que tous les logos et emblèmes du groupe TechnoKontrol Cat Global .S.L.



TECHNOKONTROL

Ms. L. Cañada

C.E.O.

lcanada@technokontrol.com

Tel +(34) 698 893 269

SALES

Mr. David Doyle

info@technokontrol.com

www.technokontrol.com

Ms. Sonia Martín

sales@technokontrol.com

Tel 902 002 005

Fax 902 002 006